



Creating healthy spaces

WHERE MAGIC HAPPENS...



TABLE OF CONTENTS

INTRO	3
RANGE	8
• CAMARGUE®	11
• SKYE®	35
• ALGARVE®	41
ALGARVE® 'CLASSIC LINE'	41
• ALGARVE® ROOF	53
• LAPURE®	65
LAPURE® 'CLASSIC LINE'	65
• LAGUNE®	71
• TOSCANE®	83
ACCESSORIES	87
TECHNICAL INFO	106
FAQ / TIPS	112
ABOUT RENSON®	118



A modern outdoor lounge area featuring a pergola with a wooden slat wall, a grey sofa, and a pool. The scene is set in a lush, green environment with trees and grass. The pergola has a dark metal frame and a wall of horizontal wooden slats. Inside, there is a grey sofa with cushions and a coffee table. A person is partially visible on the left. The pool is in the foreground, reflecting the scene. The background is filled with green trees and foliage.

WHERE MAGIC HAPPENS...

An exclusive spot where you can enjoy every season in style and the utmost comfort. Where you can catch your breath, and enjoy the peace, nature, and each other. You'll see; it'll make you a better person.

PERFECT OUTDOOR CLIMATE, DAY AND NIGHT,
IN ANY SEASON WITH **RENSON®**

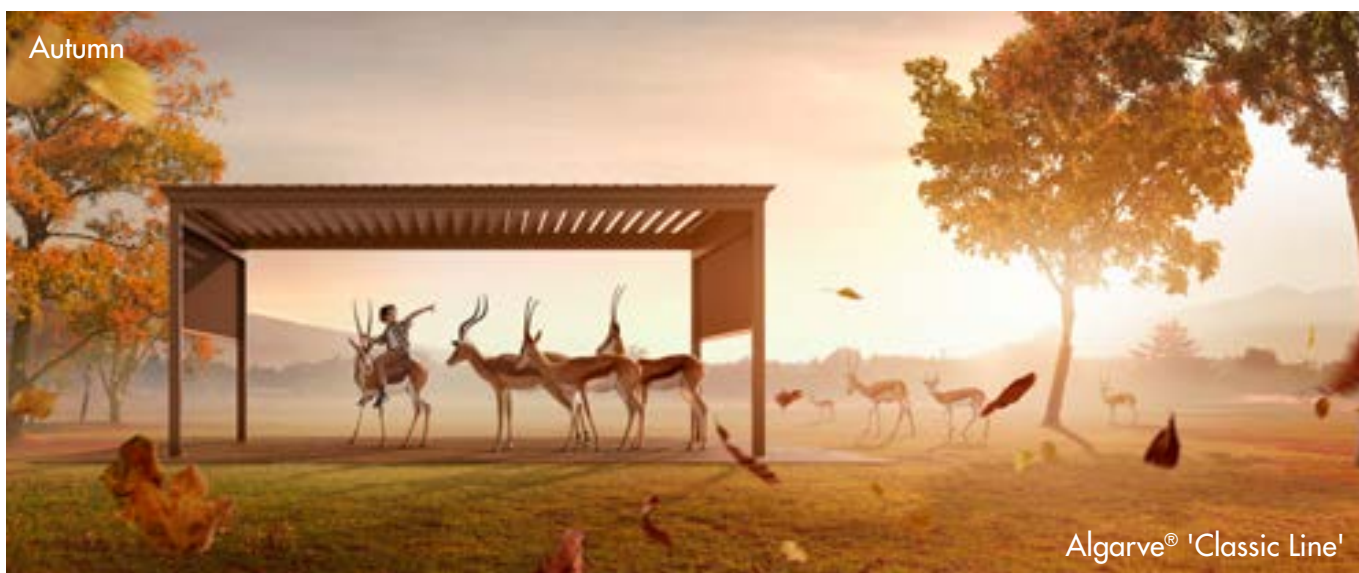

Regardless of the weather, we like to spend as much time outdoors as possible. The garden is no longer separate from the house; both form a single unit. This also makes us yearn for more atmosphere, comfort and optimal enjoyment while being outdoors. Being outside becomes living outside!

With many years of experience in sun protection screens and ventilation, Renson® is lifting the outdoor space to a higher level. Due to the right application of techniques and innovative products, it is now possible to enjoy your terrace and garden year-round.

Summer



Winter





Music

Heating element

Lighting

Sliding glass walls

Sun protection screen

Sliding panel:
Loggiawood

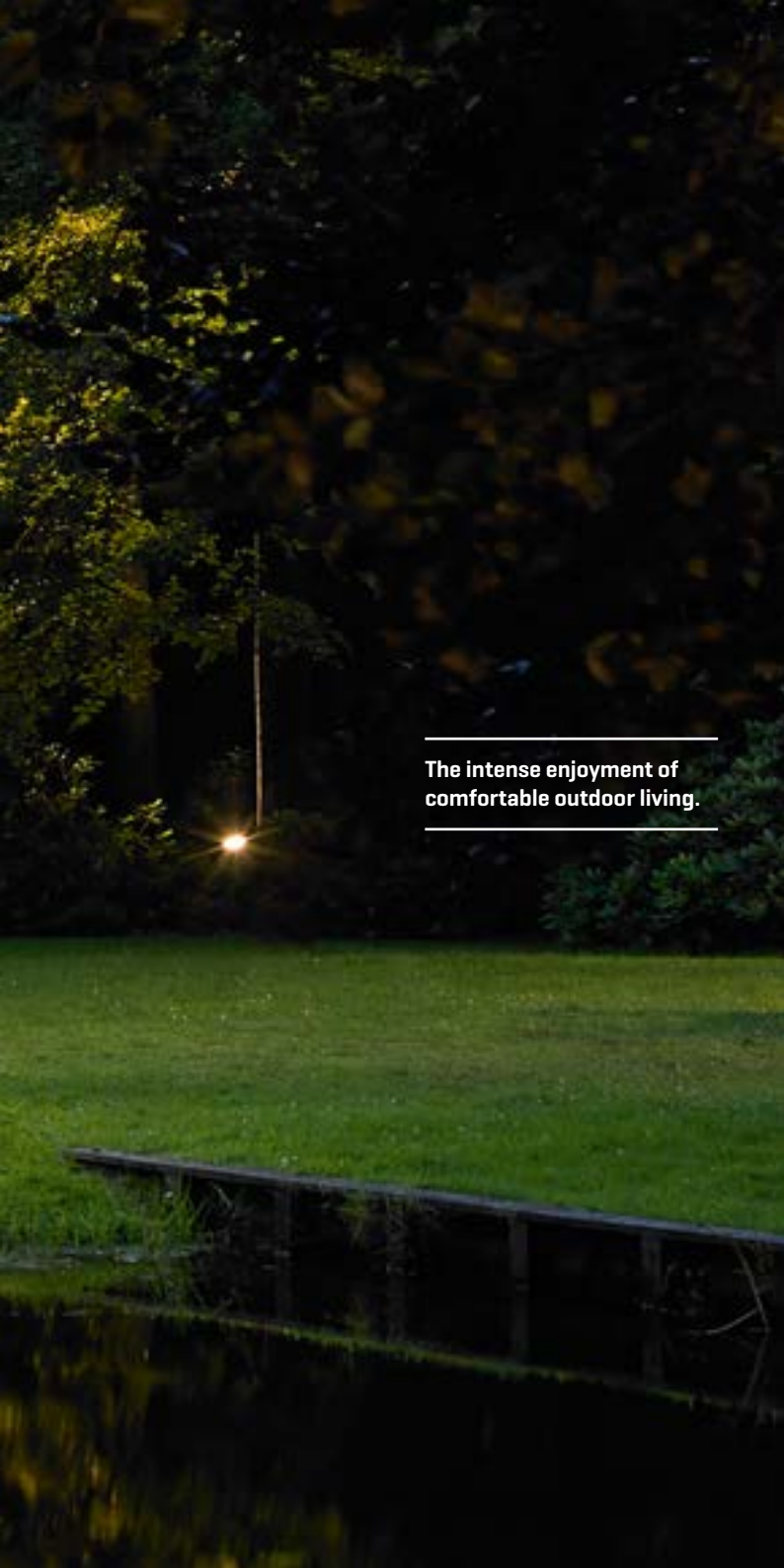

The intense enjoyment of
comfortable outdoor living.

THE ULTIMATE COMBINATION OF **QUALITY AND DESIGN**

Renson® pays a great deal of attention to the quality of the finish, a simple and flexible assembly, as well as the solidity during the development phase of its terrace coverings. The fixation parts have been made **invisible** and the electrical cables have been hidden away inside the structure. Even the floor mounting can be concealed.

You select a terrace covering to suit your own wishes. The structure can easily be blended with the most diverse range of styles – from traditional to modern or contemporary. This allows it to become an elegant and timeless extension of your home or business.

Lapure, Lagune and **Toscane** are always constructed with an angled roof against the wall. **Camargue, Skye, Algarve** and **Algarve Roof** have flat bladed roofs. There are several installation methods: free-standing with 4 columns, fitted to an outside wall with 1 or 2 columns, or integrated into an existing opening without columns. You can also join different roof components for certain types.

Renson® is also thinking of sustainability. The materials used are wear-resistant and capable of withstanding both extreme heat and extreme cold. Aluminium, screen fabrics, glass or wood – all of them are strong, maintenance-friendly materials.

BLADED ROOFS

Aluminium bladed roofs

Camargue®



Innovative, modular terrace covering with horizontal sun protection roof with rotating aluminium blades and completely invisible, integrated side elements.

Skye®



Modular, innovative and fully closable terrace covering with rotating aluminium blades that **slide open**, with completely invisible, integrated side elements.



Algarve®



Terrace covering with horizontal waterproof and sun protection roof with rotating aluminium blades. Surface-mounted side elements are available.

Algarve® Roof



Horizontal waterproof and sun protection roof with rotating aluminium blades that can be integrated into the new architecture or into existing constructions made of stone, wood or other materials.

FABRIC & SCREEN ROOFS

Screen roofs



Minimalist terrace covering with waterproof, windproof and sun protection screen roof, with an open, panoramic view.



Terrace covering made of an innovative, waterproof, windproof, transparent fabric in the roof structure with integrated side elements. The perfect cocoon.

Velum fabric roofs



New type of terrace covering with a folding roof built using patented technology, with invisible, integrated side elements, making it ideal for large surface areas.





CAMARGUE®

Experience how your life will change once you can spend more time outdoors. A timeless design and infinite options for customisation... this terrace covering adapts to suit your home. Enjoy life in style.



Music

Loggiawood®

Recessed lighting

Fixscreen®

Heating element





LED: white and RGB lighting *[more info on page 90]*



Heating element/Loudspeakers *[more info on page 91]*



Curains/Glass sliding panels/Fabric sun protection screen *[more info on page 93]*



Loggiawood Privacy sliding panels *[more info on page 96]*



Linius fixed wall *[more info on page 99]*



Loggiascreen Canvas & Loggialu Stirata *[more info on page 96]*



Wooddesign roof *[more info on page 97]*



Loggialu Wooddesign *[more info on page 97]*

Party box



Fitness box



Music

Heating element

Business box



Multifunctional use

Camargue can also be used as a:

- fitness box
- business box
- party box



Screens can be printed upon request with the design of your choosing.







Enjoy it all day long.





Would you like some sun on your terrace or perhaps not... With a single press of a button, you instantly get the situation you desire.



Screens

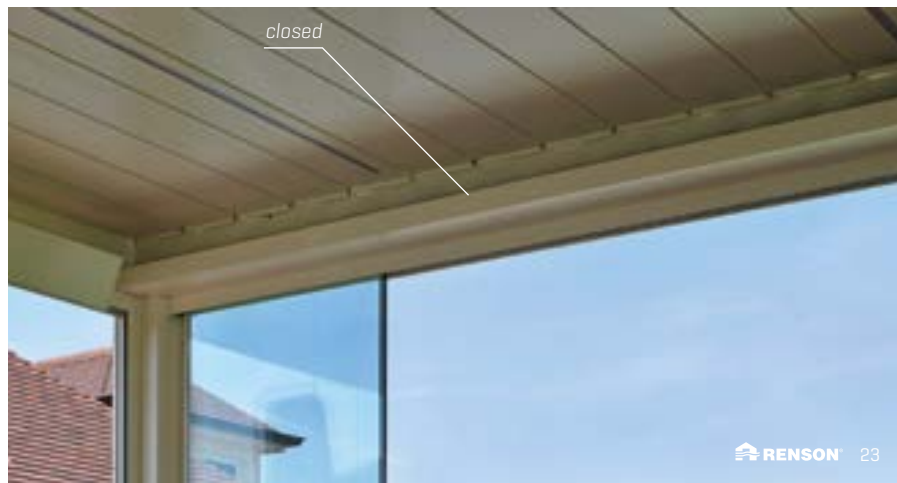

Blades

open*easily adjustable opening**closed*



CAMARGUE®

SKYE

ALGARVE®

ALGARVE® ROOF

LAPURE®

LAGUNE®

TOSCANE®

RANGE











CAMARGUE®

Innovative and modular terrace covering with horizontal sun protection roof with rotating blades.

Camargue is an innovative, modular terrace covering with a **bladed roof** that **can be closed off on all sides** using the integrated windproof Fixscreens, sliding glass walls, Loggia sliding panels, or a combination of these.

The **roof** is made of extruded aluminium blades that can be rotated to control the **sun protection and ventilation** based on the users' needs. The blades can be easily operated using a Somfy remote control. It is **water resistant** when closed.

The water is carried off to the columns via the **integrated water guide channels**. This water removal also works when the blades are rotated to an open position after it rains, so that the furniture on the terrace stays protected.

By adding side elements, you create **infinite possibilities for customisation**. **Windproof, motorised Fixscreen sun protection screens** are available in 50 colours and can be fitted with Crystal Windows. **Sliding glass doors** can be integrated, as well as in combination with integrated Fixscreens! **Loggia sliding panels** offer another option. These can be provided with the same fabric as the screens, in Western Red Cedar or aluminium blades.

A great deal of attention is also given to the **quality of the finish**. For example, the fixation parts are **practically invisible**, all of the electrical cables are hidden, and invisible floor mounting is also possible.

Camargue's high-quality materials and design **keep maintenance to a minimum**, while simultaneously guaranteeing **exceptional sustainability**.

The Camargue fits in with **any architectural style** thanks to its availability in all of the RAL colours and the various customisation options.



Efficient, integrated water drainage.

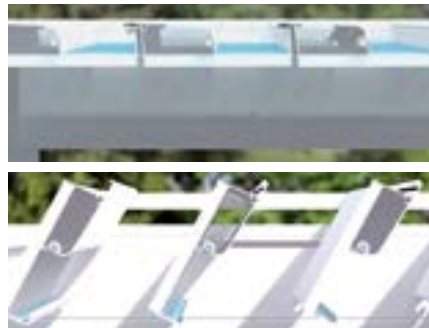

Controlled water drainage when blades are open as well.



You can operate your terrace covering easily using Somfy automation.

Dimensions and features

Roof options	Rotating aluminium blades
Dimensions	
Max. width/Pivot	6,200
Max. depth/Span	4500
Max. passage height	2,800
Joinable	joinable with multiple parts (Span and Pivot)
Min. angle	no angle [0°]
Technical specifications	
Integrated water drainage	standard (incl. PVC drainage pipes in column)
Integrated cables	standard
Integrated motor	standard
Operating switch	not applicable
RTS operation	standard
io-homecontrol® operation	not applicable
Customisation	
Triangle	not applicable
Glass roof blades - Lineo® Luce	option
Wooddesign roof blades	option
Integrated vertical windproof screens	option
Sliding door Loggiascreen® Canvas	option
Sliding glass walls	option
Combination of sliding glass walls + integrated windproof screens	option
Sliding wall in Loggiawood® / Loggialu® Wooddesign/ Loggiascreen® Canvas / Loggialu® / Loggialu® Stirata / Loggialu® Plano / Loggialu® Linea / Loggialu® Privacy / Loggiawood® Privacy	option
Windproof screens (surface-mounted) with Fixscreen® 100 ^{EVO} Slim F / Fixscreen® 150 ^{EVO} F	not applicable
UpDown LED lighting	option
Beam with Heat & Sound	option
Linus wall 1 or 2-sided	option/acoustic
Weather-resistant outdoor curtain	option

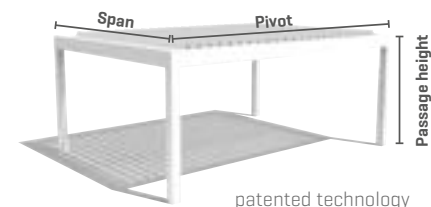

CAMARGUE®

Types of installation

There are two types of installations for the Camargue: free-standing and façade mounted.



Free-standing



Façade mounting

The frame of the Camargue is supported by four vertical columns in the **type of installation 1, free-standing** version.

For **type of installation 2, fitted to an outside wall**, one or two sides of the frame is/are mounted against a supporting, load-bearing construction/structure and partially supported by vertical columns. The blades can be positioned parallel or perpendicular to the supporting structure.

Joinable

Camargue can be extended using one of the larger Spans or Pivots to cover larger surface areas. In this case, a coupling side beam is used.



2-part joinable on the Pivot side



2-part joinable on the Span side



Multiple parts joinable on the Pivot and/or Span side

Integrated Fixscreen®

By integrating the vertical sun protection, the integrated Fixscreen, with or without Crystal windows to keep a view of the outside, you can create an extra outdoor room where the users are protected from sun, rain and wind. These screens come in 50 colours and allow you to **customize** the Camargue and create the atmosphere you desire.



Camargue fitted with an integrated Fixscreen in the Span and Pivot side

Bottom bar disappears into the box

The Camargue's frame profiles are developed in such a way that the bottom bar is aesthetically hidden away in the box when the screen is raised. Perfect integration, even afterwards!



Customisation options

Camargue can have various elements fitted to the front and/or sides. By adding side elements, you create infinite possibilities for customisation.



Loggia sliding panel: Loggia wood, Loggia wood privacy, Loggiascreen Canvas, Loggialu, Loggialu Privacy



Loggia easy passage: Loggia wood, Loggiascreen Canvas, Loggialu



Glass sliding walls



Sliding glass wall + Integrated Fixscreen

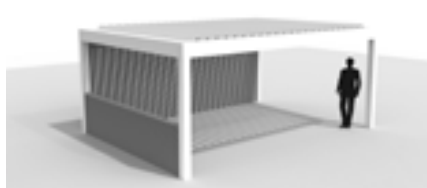

Linius fixed wall

Mounting bases

There are 3 types of mounting bases: visible, invisible, and cast mounting.

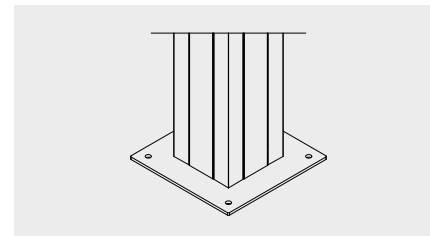

Visible mounting base

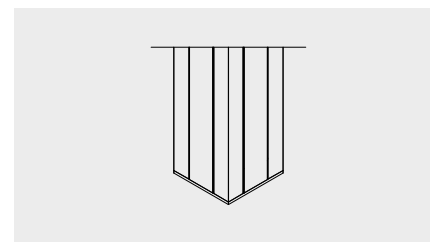

Invisible mounting foot

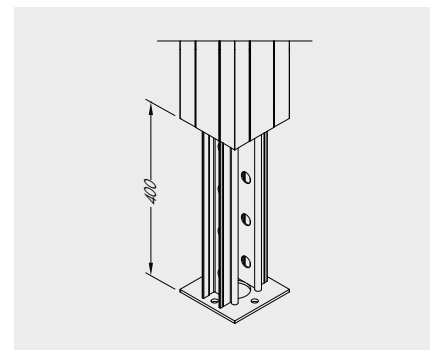

Cast mounting base





SKYE®

Modular, innovative, completely closable terrace roof with rotating aluminium blades that slide open to allow the maximum amount of light in and provide wide open views.







Loggia sliding panel and roof in the same wooddesign [more info on page 97]

- Roof blades can be rotated to allow warm air out and protect from sun, rain or wind
- Roof blades slide open to allow the maximum amount of light in and provide wide open views
- The roof is perfectly even when closed
- Double-walled blade for greater snow-bearing capacity, and sound and heat insulation
- Synchronised drive on both sides of the blades: the roof will open and close in one smooth movement even when loads are asymmetrical
- No gaps between the blades

S-DRIVE 

P A T E N T E D T E C H N O L O G Y

S-Drive Technology

Reliable, sustainable rotation and sliding technology [tilt & stack] thanks to the patented S-Drive Technology.

SKYE®

Terrace covering with sliding bladed roof

The newest, most exclusive addition to the Renson® terrace covering range has aluminium blades in the roof which rotate and slide open. The blades offer protection from the rain, sun and wind. Hot air can escape in the summer and you can slide the roof open in the winter to enjoy the sunlight to the fullest. It is still important, especially

when Skye is mounted to a wall, that sunlight can still shine into the home. The Skye terrace covering's blades are designed in such a way that they drain any precipitation laterally.

All fixations, cabling and anchoring is hidden away and the terrace covering can be fitted

with LED lights in the blades, columns or profiles, and can also be fitted with heating elements and flat panel speakers. Skye can be constructed in several ways: free-standing, fitted to an outside wall, recessed or integrated between two walls. Windproof screens, sliding glass doors or sliding panels can also be integrated.

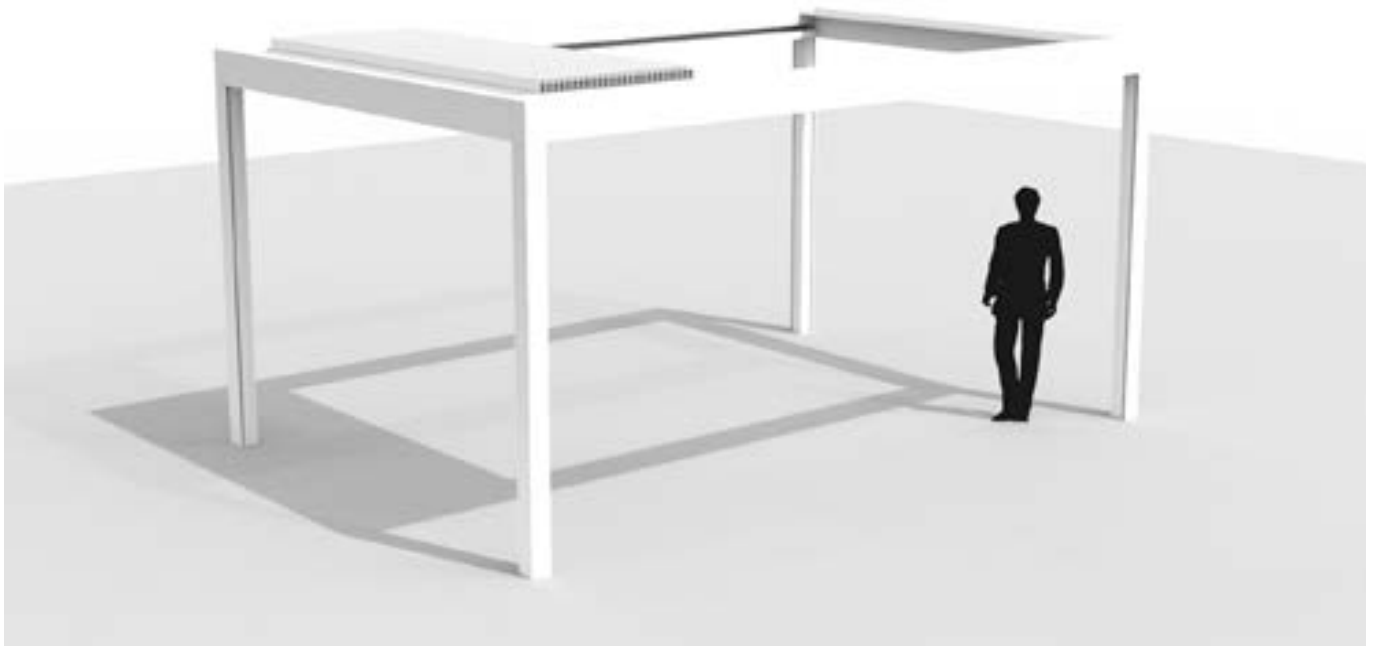

Dimensions and features

Roof options	Rotating, retractable blades
Dimensions	
Max. width/Pivot	6,200
Max. depth/Span	4500
Max. passage height	2,800
Joinable	joinable with multiple parts on the Span side
Min. angle	no angle [0°]
Technical specifications	
Integrated water drainage	standard (incl. PVC drainage pipes in column)
Integrated cables	standard
Integrated motor	standard
Operating switch	possible
RTS operation	possible
io-homecontrol® operation	not applicable
app operation	standard
Customisation	
Triangle	not applicable
Glass roof blades - Lineo® Luce	not applicable
Wooddesign roof blades	option
Integrated vertical windproof screens	option
Sliding door Loggiascreen® Canvas	option
Sliding glass walls	option
Combination of sliding glass walls + integrated windproof screens	option
Sliding wall in Loggiawood® / Loggialu® Wooddesign/ Loggiascreen® Canvas / Loggialu® / Loggialu® Stirata / Loggialu® Plano / Loggialu® Linea / Loggialu® Privacy / Loggiawood® Privacy	option
Windproof screens [surface-mounted] with Fixscreen® 100 EVO Slim F / Fixscreen® 150 EVO F	not applicable
UpDown LED lighting, column lighting	option
Beam with Heat & Sound	option
Linus wall 1 or 2-sided	option/acoustic
Weather-resistant outdoor curtain	option

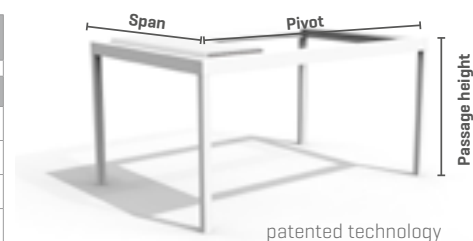





ALGARVE® ALGARVE® 'CLASSIC LINE'

A young and modern design... you can place this covering wherever you like – on your terrace, next to your swimming pool or even on its own in your garden.





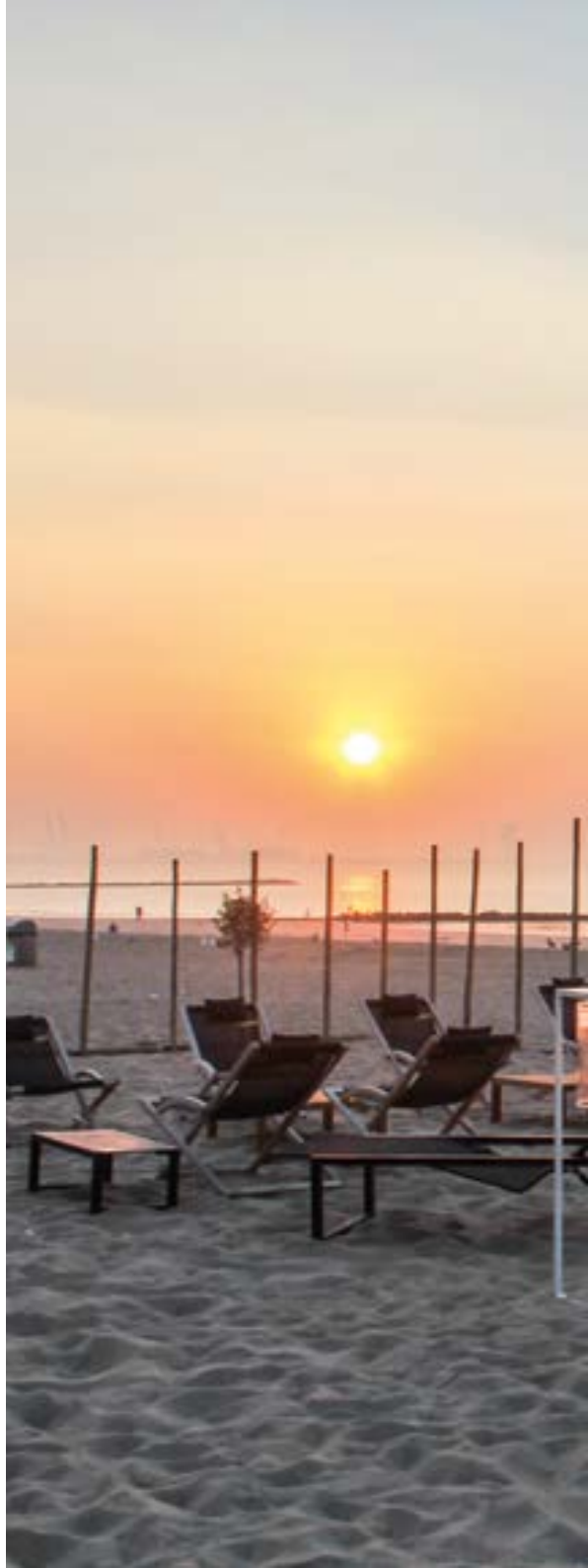

Also suitable for use in coastal regions.
All Renson® coverings receive “seaside quality”
[pre]treatment as standard.





An oasis of peace & quiet in the garden, with
or without sunshine, whatever you prefer...





Algarve “Classic Line”

Sustainable terrace covering with beautifully classic appearance

Algarve “Classic Line” is a new line in the range of terrace coverings with adjustable aluminium blades in the roof, so that you can determine for yourself how much light hits the terrace, while being protected from the rain when necessary. The classic finish, using decorative trim and lines in the columns, means that the **Algarve “Classic Line”** provides a sustainable, maintenance-friendly solution with a beautiful, classic appearance. This terrace covering can be mounted to the wall or used as a stand-alone element, making it the ideal solution for a rustic or classic architectural style.



ALGARVE®

Terrace covering with horizontal sun protection roof with rotating blades

This simple, practical terrace covering has a sun protection roof with rotating blades. The extruded aluminium blades can be rotated up to 150°, thus providing the possibility to determine for yourself how much sun protection and/or ventilation you desire.

The blades form a waterproof roof when closed. The rainwater is carried to the columns via a drainage gutter. The Algarve fits in with any architectural style, whether its contemporary, classic or modern, thanks to its elegant, light design and availability in all of the RAL colours.

Joinable!

Algarve is joinable in two parts [on the Span side] so that exceptional areas of 6 x 6.05 m can be covered without middle columns disrupting the view.



2-part joinable on the Span side



Type of installation 1 - Free-standing

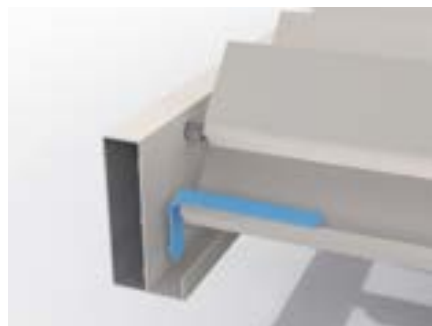

Drainage gutter



150° rotation



Type of installation 2 - Façade mounting

Dimensions and features

Roof options	Rotating aluminium blades
Dimensions [mm]	
Max. width/Pivot	6050
Max. depth/Span	4500
Max. passage height	2,800
Joinable	joinable in two parts up to 6,000 mm on the Span side without an additional column.
Min. angle	no angle [0°]
Technical specifications	
Integrated water drainage	standard
Integrated cables	standard
Integrated motor	not applicable
Operating switch	option
RTS operation	standard
io-homecontrol® operation	not applicable
Customisation	
Triangle	not applicable
Glass roof blades - Lineo® Luce	option
Wooddesign roof blades	option
Integrated vertical windproof screens	not applicable
Sliding door Loggiascreen® Canvas	not applicable
Sliding glass walls	not applicable
Combination of sliding glass walls + integrated windproof screens	not applicable
Sliding wall in Loggiaiwood® / Loggialu® Wooddesign/ Loggiascreen® Canvas / Loggialu® / Loggialu® Stirata / Loggialu® Plano / Loggialu® Linea / Loggialu® Privacy / Loggiaiwood® Privacy	not applicable
Windproof screens [surface-mounted] with Fixscreen® 100 ^{EVO} Slim F / Fixscreen® 150 ^{EVO} F	option
Integrated LED lighting/in the blade or UpDown	option
Beam with Heat & Sound	option
Linus wall 1 or 2-sided	option/acoustic

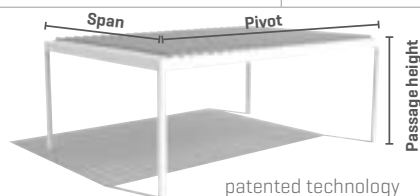

Fixscreen® 100^{EVO} Slim F / Fixscreen® 150^{EVO} F - Algarve®

To close off the sides of the Algarve, it can be combined with the Fixscreen 100^{EVO} Slim F and the Fixscreen 150^{EVO} F. This allows the box for the sun protection screen to be mounted underneath the frame profiles so that this connects perfectly with the basic construction.

Technical specifications Fixscreen® ^{EVO}		
[mm]	Fixscreen® 100 ^{EVO} Slim (F)	Fixscreen® 150 ^{EVO} (F)
Box (W x H)	110 x 150	155 x 150
Dimensions		
Maximum (W x H) screen	4,500 x 2,800	6,000 x 2,800
Bottom bar (W x D)	30 x 53 disappears into the box	
Closed side guide (C) (W x D)	35 x 48	
Deep side guide (D) (W x D)	35 x 110	35 x 150







ALGARVE® ROOF

A stylish and functional solution to integrate into your architecture.





It is also the perfect solution for your
apartment terrace.





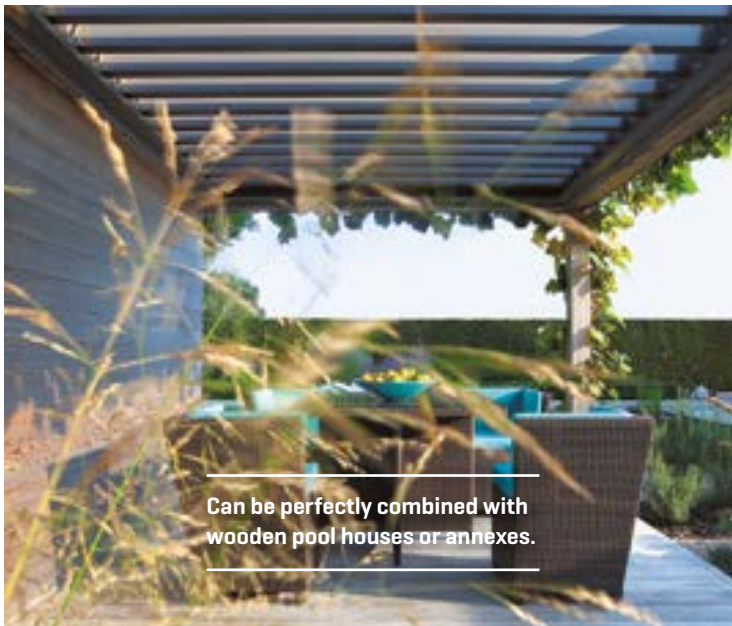



The combination of wooden and aluminium...
perfect harmony





ALGARVE[®] ROOF

Innovative and modular terrace covering with horizontal sun protection roof with rotating blades

Horizontal sun protection roof with adjustable blades can be integrated into existing constructions

This simple roof structure, without columns but with rotating blades, creates a sun protection roof.

The extruded aluminium blades can be rotated up to 150°, thus providing the possibility to determine for yourself how much sun protection and/or ventilation you desire.

The blades form a waterproof roof when

closed. The rain water is carried to the corners via a drainage gutter.

The Algarve fits in with any architectural style thanks to its elegant, light design and availability in all of the RAL colours: contemporary, classic or modern.

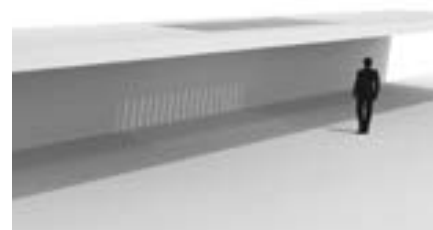

Type of installation 3 - Integration



Type of installation 4 - Surface mounting

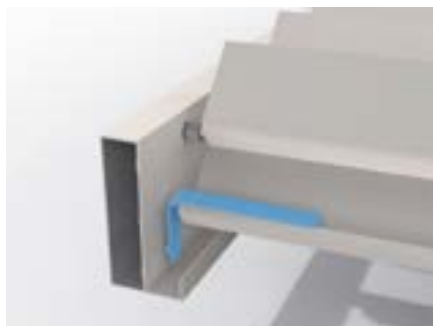

Drainage gutter



150° rotation

Dimensions and features

Roof options	Rotating aluminium blades
Dimensions	
Max. width/Pivot	6050
Max. depth/Span	4500
Standard passage height	not applicable
Joinable	joinable in two parts up to 6,000 mm on the Span side without an additional column
Min. angle	no angle [0°]
Technical specifications	
Integrated water drainage	standard
Integrated cables	standard
Integrated motor	not applicable
Operating switch	option
RTS operation	standard
io-homecontrol® operation	not applicable
Customisation	
Triangle	not applicable
Glass roof blades - Lineo® Luce	option
Wooddesign roof blades	option
Integrated vertical windproof screens	not applicable
Sliding door Loggiascreen® Canvas	not applicable
Sliding glass walls	not applicable
Combination of sliding glass walls + integrated windproof screens	not applicable
Sliding wall in Loggiawood® / Loggialu® Wooddesign/ Loggiascreen® Canvas / Loggialu® / Loggialu® Stirata / Loggialu® Plano / Loggialu® Linea / Loggialu® Privacy / Loggiawood® Privacy	not applicable
Windproof screens [surface-mounted] with Fixscreen® 100 EVO Slim F / Fixscreen® 150 EVO F	option
Integrated LED lighting/in the blade or UpDown	option
Beam with Heat & Sound	option
Linus wall 1 or 2-sided	not applicable
Weather-resistant outdoor curtains	not applicable

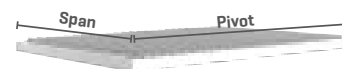

patented technology





LAPURE®

Minimalist terrace covering with waterproof, windproof and sun protection screen roof, with an open, panoramic view.

DAY



EVENING



Modern

There are two versions. The first has end columns, and the second has a roof overhang that juts out past the columns so as to provide the optimum amount of shade across the entire terrace.

Classic - "Classic Line"

There is no visually disruptive lateral connection when open, which creates a beautiful "infinity view".

LAPURE®

Minimalist terrace covering with waterproof sun protection screen roof

The stylish, **minimalist** Lapure consists of a windproof, waterproof, sun protection screen roof that rests on elegant, discrete aluminium columns **with no disruptive lateral connection**. It is anchored to an existing façade.

When the roof is closed, the Lapure provides protection from the sun, wind and rain. When the roof is open, you can enjoy the sun as the **delicate structure** is not visually disruptive.

There are two types of columns for the Lapure: **“end columns”** with water drainage (via side guides and columns, even when half open). You can also opt for **“shifted columns”** (with roof overhang and water drainage via gutters, even when half open). The latter has a roof overhang that juts out past the columns so as to provide the optimum amount of shade. This lets you enjoy enough shade, even when the sun is low in the sky, for instance (installation on west-facing façades).

A **“coupled”** version of both types is also available so that two or more roofs can be installed perfectly next to one another so that they span across larger areas (just 1 column to be joined).

Thanks to the wide range of colours for the structure and the screen fabric, the Lapure blends in to every environment and suits every architectural style.

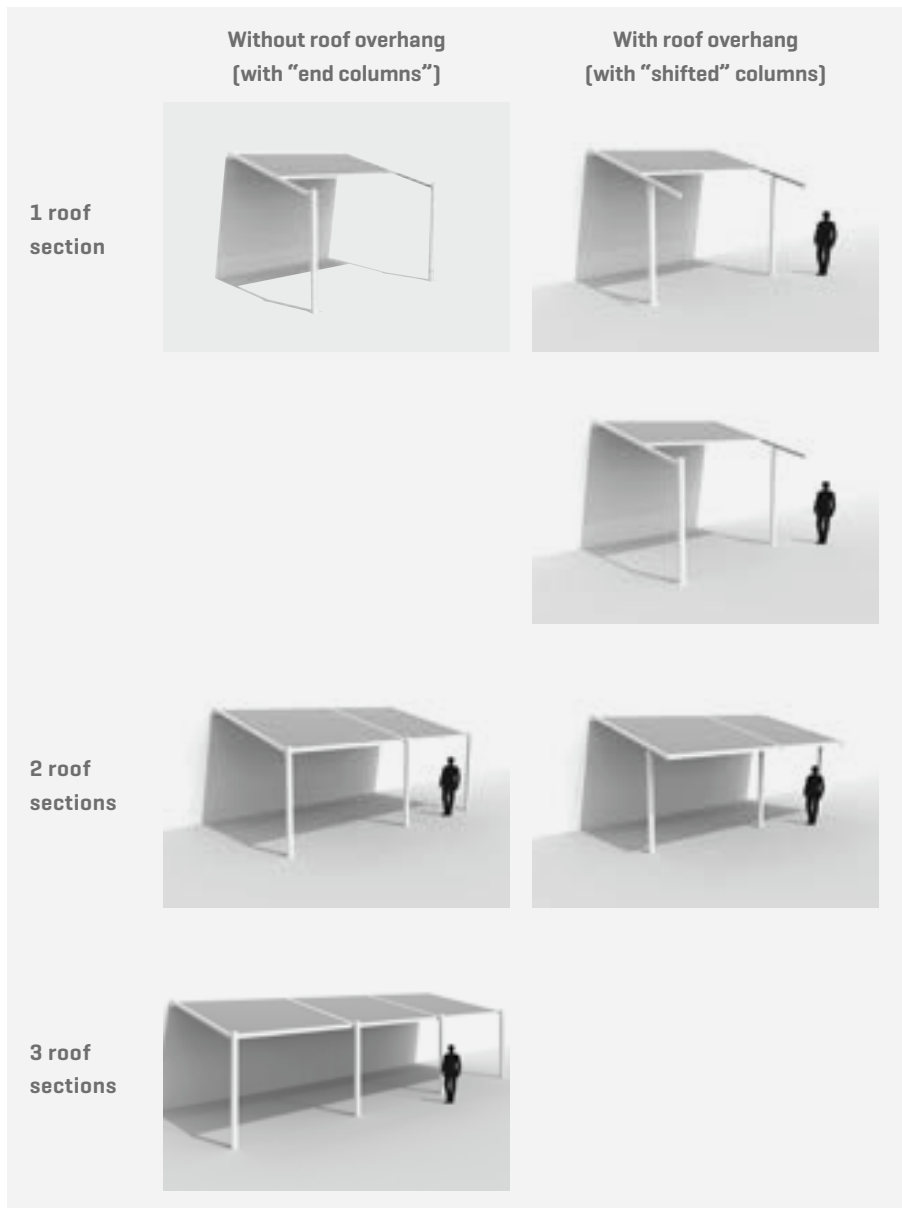

Dimensions and features

Roof options	Retractable waterproof, translucent sun protection screen	
Dimensions		
Max. width/Pivot	6000*	
Max. depth/Span	5000	
Max. passage height	2900	
Joinable	joinable up to max. width of 18 m	
Min. angle	10°	
Technical specifications		
Integrated water drainage	standard (depending on the type)	
Integrated cables	standard	
Integrated motor	standard	
Operating switch	not applicable	
RTS operation	standard	
io-homecontrol® operation	option at no extra cost	
Customisation		
Triangle	option	
Glass roof blades - Lineo® Luce	not applicable	
Wooddesign roof blades	not applicable	
Integrated vertical windproof screens	not applicable	
Sliding door Loggiascreen® Canvas	option	
Sliding glass walls	not applicable	
Combination of sliding glass walls + integrated windproof screens	not applicable	
Sliding wall in Loggiawood® / Loggialu® Wooddesign / Loggiascreen® Canvas / Loggialu® / Loggialu® Stirata / Loggialu® Plano / Loggialu® Linea / Loggialu® Privacy / Loggiawood® Privacy	not applicable	
Windproof screens [surface-mounted] with Fixscreen® 100 ^{EVO} Slim F / Fixscreen® 150 ^{EVO} F	option	
Integrated LED lighting	option	
Beam with Heat & Sound	option	
Linus wall 1 or 2-sided	not applicable	

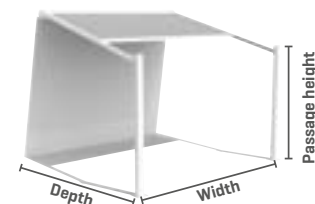

patented technology



Coupled version with end column

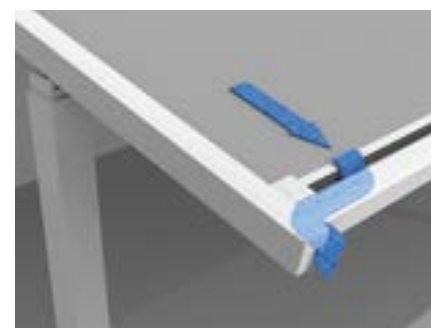

With shifted columns

* 1 roof section between 4 and 6 m: a connector bar [with or without LED] must be used







LAGUNE®

Ultimate luxury and wellness on your terrace. Live outdoors in your stylish and comfortable space throughout the year. Have your terrace roof completely open or closed... You can change it with a single push of a button.

Sun protection roof with
transparent fabric.



Protected from excessive sunlight or wind
without sacrificing your view of your garden...
Thanks to the integrated Crystal Windows.



Depending on where the sun is, your roof elements will open or close as you wish.

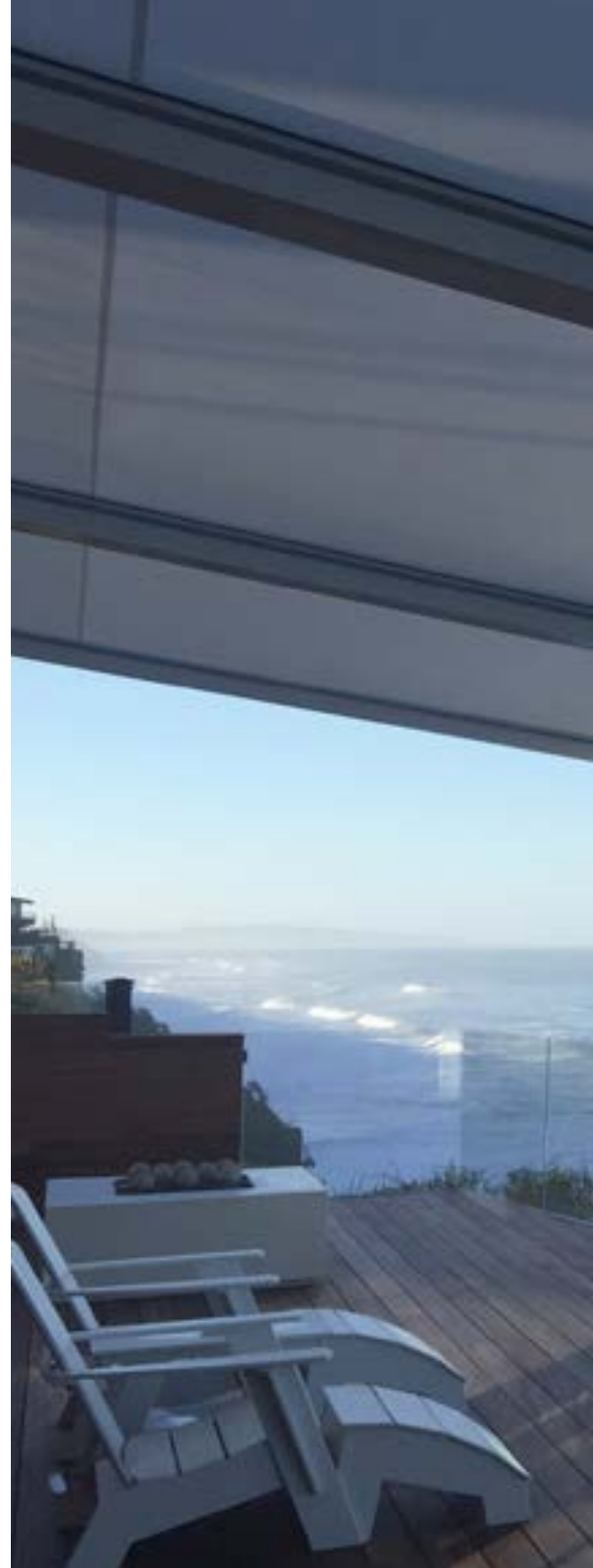

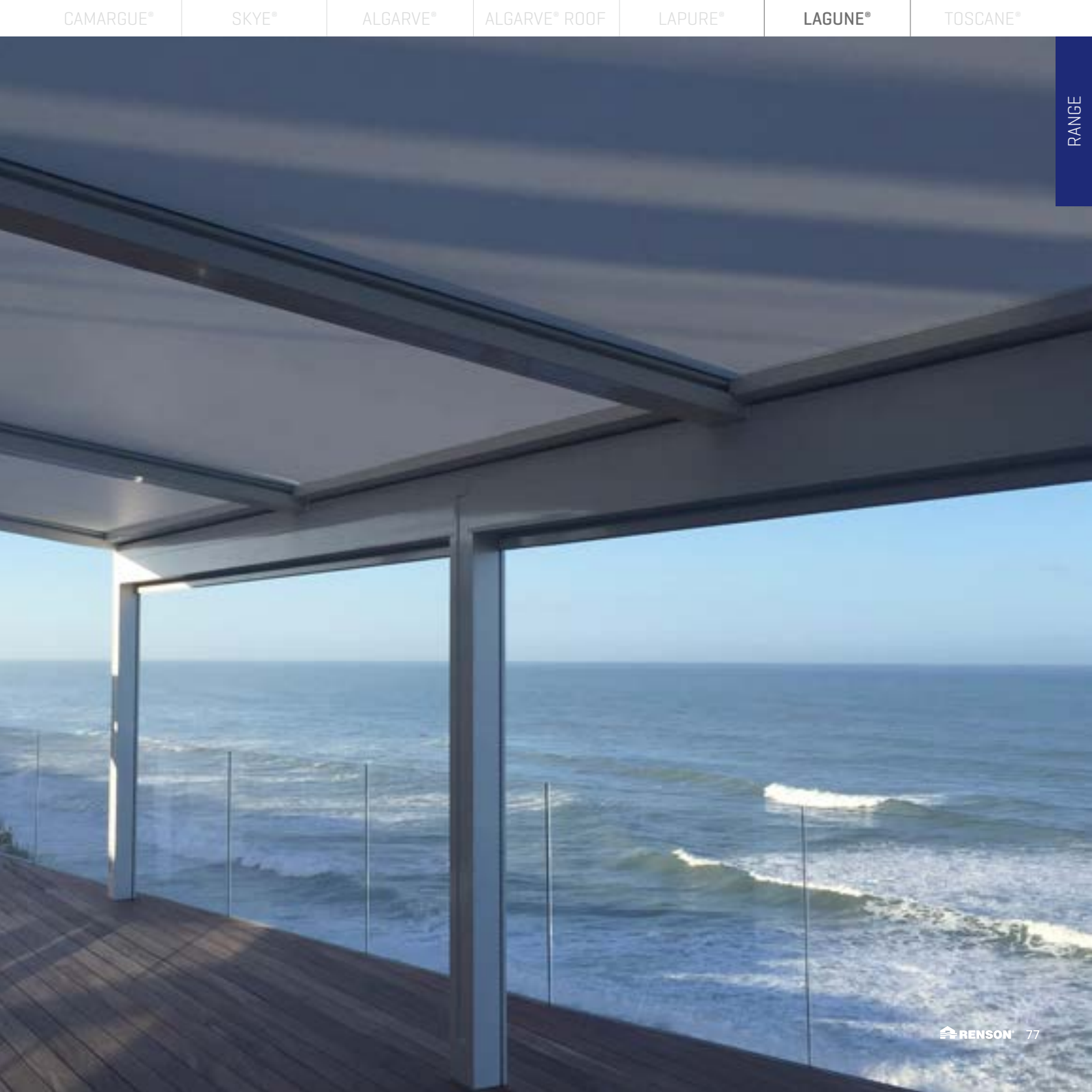

LAGUNE®

Terrace covering with innovative, transparent fabric in the roof structure

This terrace covering consists of an **aluminium structure** with **integrated Fixscreen technology**. The sun protection is completely integrated into the structure, creating an aesthetic unit. Thanks to the modular structure, the entire unit is easy to expand, even afterwards.

The **Fixscreen technology** combined with **optimum screen tension** ensures that rainwater is drained via the guiding channels hidden within the structure.

Even if the sun protection screen is not fully unrolled, the water that falls on it is drained away via this **integrated water-drainage system**.

A great deal of attention is also given to the **quality of the finish**. For example, the fixation parts are **practically invisible**, all of the electrical cables are hidden, and invisible floor mounting is also possible.

Lagune's high-quality materials and design **keep maintenance to a minimum**, while simultaneously guaranteeing **exceptional sustainability**.

The Lagune fits in with **any architectural style** thanks to its availability in all of the RAL colours and the various customisation options.



Construction situation 1 - Against a supporting construction [standard]



Construction situation 2 - Against a supporting, left- and right-side construction



Construction situation 3 - Against a supporting and left-side construction



Construction situation 4 - Against a supporting and right-side construction

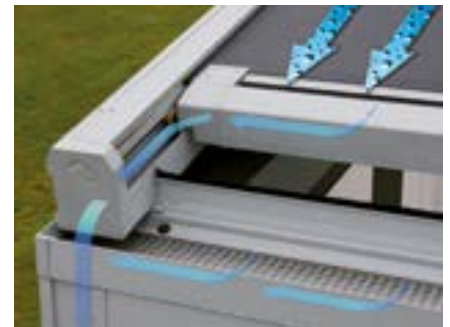

Integrated water drainage



Integrated water drainage

Dimensions and features

Roof options	Retractable waterproof, translucent sun protection screen
Dimensions	
Max. width	6,000
Max. depth	6,200
Max. passage height	2,500
Joinable	joinable to max. width of 12 m
Min. angle	8°
Technical specifications	
Integrated water drainage	standard (incl. PVC drainage pipes in column)
Integrated cables	standard
Integrated motor	standard
Operating switch	not applicable
RTS operation	option at no extra cost
io-homecontrol® operation	standard
Customisation	
Triangle	option
Glass roof blades - Lineo® Luce	not applicable
Wooddesign roof blades	not applicable
Integrated vertical windproof screens	option
Sliding door Loggiascreen® Canvas	option
Sliding glass walls	option
Combination of sliding glass walls + integrated windproof screens	option
Sliding wall in Loggiawood® / Loggialu® Wooddesign / Loggiascreen® Canvas / Loggialu® / Loggialu® Stirata / Loggialu® Plano / Loggialu® Linea / Loggialu® Privacy / Loggiawood® Privacy	option (Side)
Windproof screens [surface-mounted] with Fixscreen® 100 ^{EVO} Slim F / Fixscreen® 150 ^{EVO} F	not applicable
Integrated LED lighting	option
Beam with Heat & Sound	option
Linius wall 1 or 2-sided	not applicable

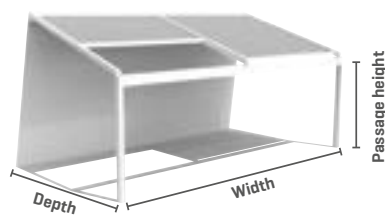

patented technology

Depending on the width of the Lagune®, there are four basic models:



Basic model 1

1,500 mm < width ≤ 4,000 mm



Basic model 2

4,000 mm < width ≤ 6,000 mm



Basic model 3

6,000 mm < width ≤ 8,000 mm



Basic model 4

8,000 mm < width ≤ 12,000 mm

Customisation options

Lagune can have various elements fitted to the front and/or sides. By adding side

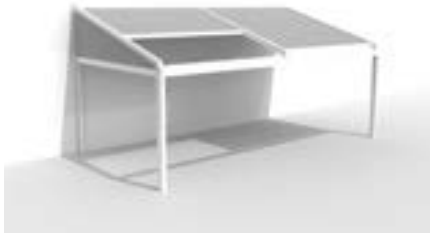

Triangle



*Loggia Schuifwand in Loggiawood /
Loggialu wooddesign/ Loggiascreen Canvas /
Loggialu / Loggialu Stirata / Loggialu Plano /
Loggialu Linea*



Sliding glass wall

elements, you create infinite possibilities for customisation.



Integrated Fixscreen

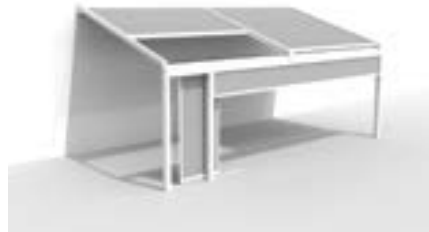

*Loggia easy passage: Loggiawood /
Loggialu wooddesign / Loggiascreen Canvas /
Loggialu / Loggialu Stirata / Loggialu Plano /
Loggialu Linea*

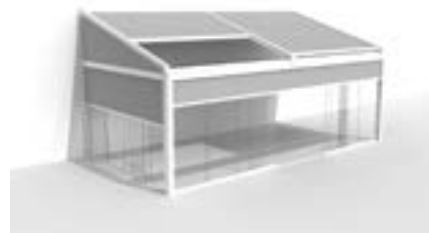

Sliding glass wall + Integrated Fixscreen

Integrated Fixscreen®

By integrating the vertical sun protection, the integrated Fixscreen, with or without Crystal windows to keep a view of the outside, you can create an extra outdoor room where the users are protected from sun, rain and wind. These screens come in 50 colours and allow you to **customise** the Lagune and create the atmosphere you desire.

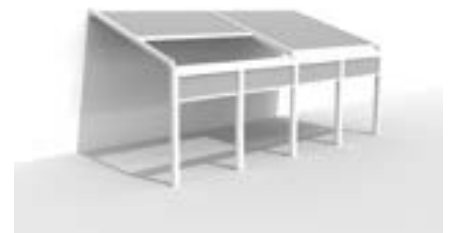

*Lagune is fitted with multiple integrated
Fixscreen in the Front*



*Lagune is fitted with multiple integrated
Fixscreen in the Side*

Triangle - Lagune®

In order to make the integration possible in the Lagune Side, it is necessary to fit this with Lagune Triangle. Lagune is fitted with a vertical wall profile and an additional box

in this case. The triangle that is created between the Lagune's box and side channel is filled with a fibreglass fabric of your choosing.







TOSCANE®

The sliding, folding roof of this sleek, modular terrace covering is operated using patented technology. Toscane was specially developed for large terraces of up to 6.5 m x 13 m with a single-fabric screen roof.

TOSCANE®

Sleek, modular terrace covering with a sliding, folding roof operated using patented technology.

Toscane is waterproof, windproof sun protection with an integrated drainage system.

Large dimensions, with a maximum width of 6,500 mm projection x 13,000 mm width with a single-fabric screen roof, are available, which makes this product perfect for use in the hotel and catering industry.

Toscane can have an angle of inclination from 4° to 20°, depending on the span.

Moreover, different side variation integrations, including Fixscreen, glass walls and Loggia sliding panels, are possible. Various types of roof screens are available.

To create sustainable, soft lighting, Toscane is available with integrated LED lighting.

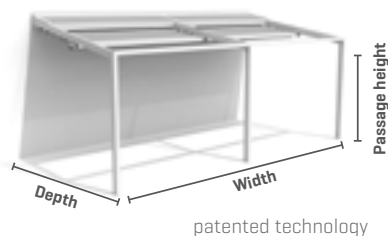

Dimensions and features

Roof options	Aluminium terrace covering with folding roof
Dimensions	
Max. width/Pivot	4500
Max. depth/Span	6500
Max. passage height	2,500
Joinable	joinable up to 13 m with a single-fabric screen
Min. angle	starting at 4° (depending on the width)
Technical specifications	
Integrated water drainage	standard
Integrated cables	not applicable
Integrated motor	standard
Operating switch	not applicable
RTS operation	standard (Somfy external receiver)
io-homecontrol® operation	not applicable
Customisation	
Triangle	option
Glass roof blades - Lineo® Luce	not applicable
Wooddesign roof blades	not applicable
Integrated vertical windproof screens	option (Front)
Sliding door Loggiascreen® Canvas	not applicable
Sliding glass walls	option
Combination of sliding glass walls + integrated windproof screens	option
Sliding wall in Loggiawood® / Loggialu® Wooddesign / Loggiascreen® Canvas / Loggialu® / Loggialu® Stirata / Loggialu® Plano / Loggialu® Linea / Loggialu® Privacy / Loggiawood® Privacy	option (Front)
Windproof screens [surface-mounted] with Fixscreen® 100 ^{EV0} Slim F / Fixscreen® 150 ^{EV0} F	option (Side)
Integrated LED lighting	option
Beam with Heat & Sound	option
Linius wall 1 or 2-sided	not applicable





Music

Recessed lighting

Sun protection screen



Sliding panels

Heating element

ACCESSORIES

Create the terrace covering that you want. Accessories that meet everyone's comfort and needs are available.

WEATHER-RESISTANT

Can be closed to block out rain and wind

Lapure and **Lagune** are terrace coverings with waterproof, transparent sun protection screens. The Fixscreen technology combined with optimum screen tension ensures that rainwater is drained off via hidden channels. Even if the sun protection screen is not fully

unrolled, the water that falls on it is drained away via this integrated water-drainage system.

Camargue, **Algarve** and **Algarve Roof** are terrace coverings with rotating blades in the

roof. These patented blades are designed in such a way that the water is drained off to the side even if the blades open up after it rains.



Lagune can drain an amount of water equivalent to rains with an intensity of 180 mm/hr that last up to 2 minutes. These kinds of rains occur on average once every 15 years in Belgium. [See Belgian rain statistics: NBN B 52-011 norm]

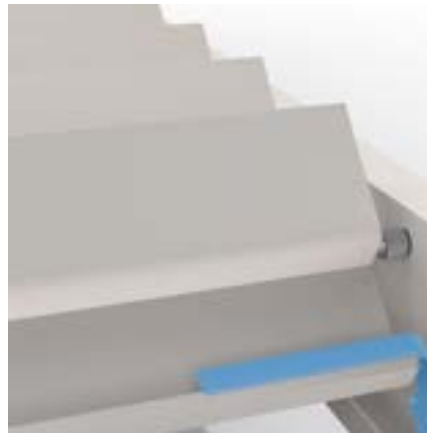

Algarve can drain an amount of water equivalent to rains with an intensity of between 144 mm/hr and 180 mm/hr that last up to 2 minutes. These kinds of rains occur on average once every 10 years in Belgium. [See Belgian rain statistics: NBN B 52-011 norm]



Camargue can drain an amount of water equivalent to rains with an intensity of 180 mm/hr that last up to 2 minutes. These kinds of rains occur on average once every 15 years in Belgium. [See Belgian rain statistics: NBN B 52-011 norm]

LIGHTING, HEATING AND MUSIC

Enjoy every moment of the day.

When it starts to get dark, you simply switch on the integrated **lighting**. The choice of lighting lets you create the desired mood and feeling.

You can continue to enjoy your terrace, even when it starts getting colder. **Heating elements** can be provided to make this possible.

The radiated heat ensures an even distribution of warmth throughout the space with a minimum of heat loss.

Thanks to the integrated flat panel speakers, you can even enjoy your favourite **music** on your terrace.

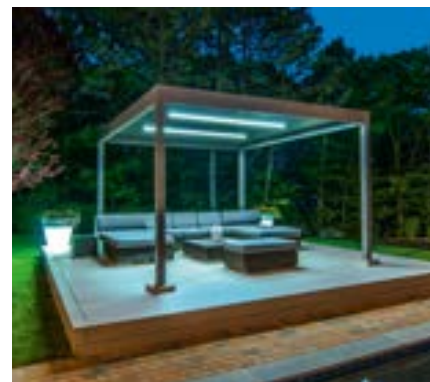

A | LIGHTING

You can choose between cool or warm white lighting to create the desired mood and feeling.

Moreover, the LED lighting in most coverings can be **dimmed** so that the intensity of the lighting can be adjusted to the situation.

The lighting for **Lagune** and **Toscane** is integrated into the roof structure.

You can opt for LED lighting that is integrated into the roof blades in **Camargue**, **Algarve** and **Algarve Roof**. Upwards or downwards lighting can also be provided on the inside of the frame. It is also possible to integrate atmospheric lighting into the **Camargue** and **Skye** columns.

You can choose between warm white light [perfect for cosy gatherings with friends], pure white light [perfect for reading] and RGB [only for uplighting in the frame] to create the desired mood and feeling. Moreover, the LED lighting can be dimmed so that the intensity of the lighting can be adjusted to the situation. The Renson® LED lighting's exceptionally sustainable quality ensures even lighting without any bright spots.

The LEDs can be dimmed.

	Warm white light	Pure white light	RGB [colour]
Lagune® LED Light*	✓	✓	
Lineo® LED Light*	✓	✓	
Colomno LED Light**	✓	✓	
UpDown LED Light** Upwards	✓	✓	✓
UpDown LED Light** Downwards	✓	✓	
Toscane® LED Light*	✓	✓	
Lapure® LED Light*	✓	✓	

* Warm white: 2,100 lm/m [180 LEDs/m]
Pure white: 2,340 lm/m [180 LEDs/m]
** Warm white: 550-680 lm/m [120 LEDs/m]
Pure white: 550-680 lm/m [120 LEDs/m]
RGB: 570-700 lm/m [60 LEDs/m]



Colomno LED Light

LED lighting integrated into the **Camargue** and **Skye** columns. A maximum of one LED strip can be integrated into each column (on the inside of the column). There can be a total of four columns fitted with integrated LED Light lighting per roof section.



Integrated column lighting



UpDown LED Light

Integrated LED lighting on the inside of the frame. Fitted with lighting running upwards and/or downwards. This lets you create indirect or direct atmospheric lighting with the **Camargue**, **Skye** and **Algarve**. A total of two UpDown LED lighting modules can be installed per roof section. This can only be done on either the Pivot side or the Span side.



Upwards lighting
Downwards lighting



Lagune® LED Light

Integrated LED lighting in the side channels of the Rooffix - **Lagune**.



Lineo LED Light

LED lighting integrated into the **Camargue** and **Algarve** blades. Even distribution without visible bright spots thanks to high-quality LEDs [180 per metre].



Toscane® LED Light

Integrated pure or warm white LED lighting in the roof screen profiles.



Lapure® LED Light

Integrated LED lighting in the side channels of the Rooffix - **Lagune**.

B | HEATING AND LOUDSPEAKERS

Integrated LED Light lighting, heating and sound are the perfect addition to **Camargue**, **Skye**, **Algarve**, **Algarve Roof** and **Lagune**.

Thanks to these extra features, the terrace can be used from early morning to late evening, all year round.

The Beam is also available separately. Moreover, these additions can be perfectly integrated afterwards.

The **Beam** design beam with **Heat & Sound**



Integrated heating elements and loudspeakers.

Heated enclosures

To enjoy your heater to the fullest, we recommend adding components (such as glass walls, Fixscreen, etc.) that will enclose the terrace covering.



Perfect heater position

The perfect position for the heater is across from the fixed wall so that you can enjoy the reflected heat.



Heat & Sound Beam

It is best to install a Beam with heat on both sides to ensure optimum heat distribution within the covering.

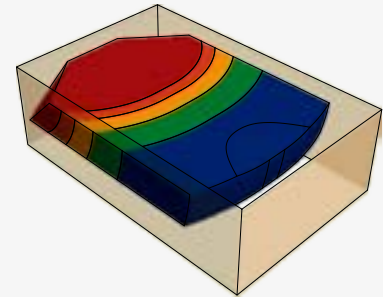

Heated effect with 1 side heated
[6 x 4 m format].

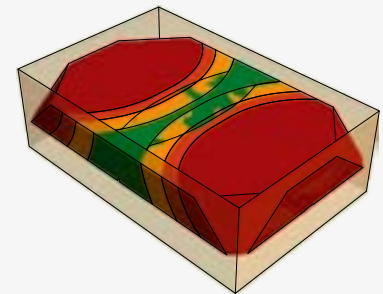

Heated effect with 2 sides heated
[6 x 4 m format].

SIDE ELEMENTS (CAMARGUE®, ALGARVE®, SKYE®, LAGUNE® AND TOSCANE®)

Endless customisation options

Camargue, Lagune and **Toscane** can have various elements [such as sun protection fabric, sliding panels, glass walls, etc.] fitted to the front and/or sides. This results in endless customisation options.

The front and/or the sides of the **Algarve** can be fitted with vertical sun protection.

Lowered windproof, motorised Fixscreens create a protective cocoon. Thanks to the partial transparency of the screens and the use of Crystal windows, you don't lose the

view of the garden. You've also got a wide range of colours to choose from. Every colour combination is possible and can perfectly be combined with other materials, such as the garden furniture. In the open position, the **integration of the screens is invisible** and the motors are also completely concealed in the structure.

You can also opt for **sliding glass walls**. When combined with windproof screens, you also retain the benefit of sun protection.

Elegant **Loggia sliding panels with windproof screen fabrics** or **[adjustable or fixed] wooden or aluminium blades** are also an option. Wood [particularly cedar] has made a comeback and is easy to combine with other materials.

You can even opt for a two-toned colour finish when you combine sliding panels with aluminium blades.



OUTDOOR CURTAINS (CAMARGUE®, ALGARVE® AND SKYE®)

Fitted with curtains for outdoor use

Camargue, Algarve and **Skye** can be fitted with outdoor curtains. This allows you to create a fairy-tale atmosphere under your covering.

These polyester curtains for outdoor use are water-resistant, mould-resistant and repel dirt.

Moreover, they have a constant weather-resistance and colourfastness, even after washing. This will not wrinkle.

The curtains are delivered completely made to order.

Moreover, they can be combined in the Skye and Camargue with sliding glass walls and integrated Fixscreens

The outdoor curtains can always be combined with Updown LED lighting. This gives the terrace covering a romantic feel at twilight.



SLIDING GLASS WALLS (CAMARGUE®, SKYE®, LAGUNE® AND TOSCANE®)

Increased elegance thanks to completely transparent sliding walls.

You can also choose to install sliding glass walls. Completely transparent sliding walls increase the elegance of the **Camargue, Skye, Lagune** and **Toscane**. This also protects you from the weather and wind, and the terrace covering can be completely enclosed to prevent theft.

You can of course always integrate the vertical, windproof Fixscreen sun protection together with a sliding glass wall, which keeps the major advantage of sun protection.

Plus, you can combine the glass wall with the outdoor curtains, even when already combined with the integrated Fixscreens.

Integration

Camargue and **Skye**:
available in Span and/or Pivot

Lagune and **Toscane**:
available in Side and/or Front





The Camargue is fitted with sliding glass walls and integrated Fixscreens in the Span and Pivot side



The Lagune is fitted with sliding glass walls in the Side and Front

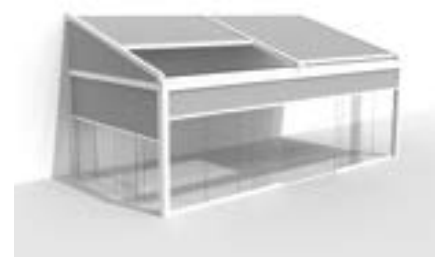

The Lagune is fitted with sliding glass walls and integrated Fixscreen in the Side and Front

Distribution of sliding glass walls

$1,500 \leq X \leq 2,500$ Width X	$2,500 < X \leq 3,750$ Width X	$3,750 < X \leq 5,250$ Width X	$5,250 < X \leq 6,500$ Width X
3 panels	4 panels	6 panels	8 panels
3 rails	4 rails	3 rails	4 rails
Opens to the left Or opens to the right	Opens to the left Or opens to the right	Opens to the left and opens to the right	Opens to the left and opens to the right
Incl. 1 handle	Incl. 1 handle	Incl. 2 handles	Incl. 2 handles

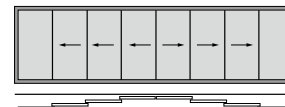
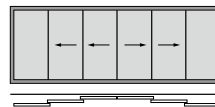
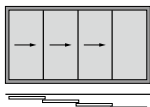
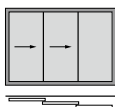

LOGGIA SLIDING PANELS® (CAMARGUE®, SKYE®, LAGUNE® AND TOSCANE®)

You control the amount of light that comes in

With the vertical sun protection sliding panels, we can even influence the way sunlight penetrates under your terrace

covering [dynamic sun protection]. Sun protection sliding panels are made of aluminium frames with:



Loggialu

Loggialu
Plano

Loggiawood

Loggialu
Privacy

Loggiawood
Privacy

Loggiascreen
Canvas

Loggialu
Stirata

Loggialu Linea

Wooddesign

Privacy

Manually adjustable wooden or aluminium blades. The **Privacy** model of the Loggiawood and Loggialu sliding panels have blades that can be rotated manually from fully closed or open [applicable for **Camargue**].

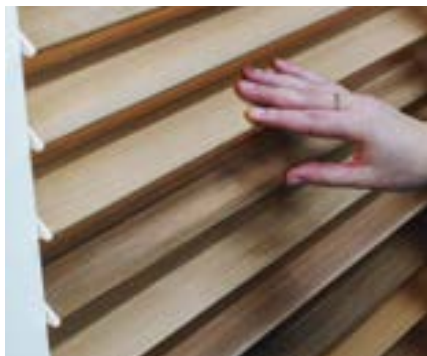



Camargue fitted with Loggiawood sliding panels on the Span side



Lagune fitted with Loggiawood sliding panels on the Span side

Types

- Loggiawood: wooden blades (Western Red Cedar)
- Loggiawood Privacy: rotating wooden blades (Western Red Cedar)
- Loggiascreen Canvas: fabric screen (fibreglass)
- Loggialu: aluminium blades
- Loggialu Privacy: rotating aluminium blades

Integration

Camargue and **Skye**: available in Span and/or Pivot

Lagune: available in Side

Toscane: available in Front



Wooddesign

Camargue, Skye and Algarve, fitted with aluminium roof blades in wooddesign

- Natural appearance of wood combined with the advantages of aluminium in terms of:
 - Ease of maintenance
 - Colourfastness
 - Maintains the shape
- Also available for the LED blades
- Combines perfectly with the Loggialu Wooddesign sliding panels
- Roof blade in wooddesign (frame and columns have standard coating)
- Available in 3 types:
 - White oak
 - Natural oak
 - Walnut



White oak



Natural oak



Walnut

LINIUS WALL (CAMARGUE®, ALGARVE® AND SKYE®)

Physical barrier or decorative finish for the underlying wall

The Linius bladed wall, in the Algarve, Camargue or Skye, lets you create a physical barrier and decorative finish.

The Linius fixed wall is available as a single or a double-sided, cladded wall across the entire passage height, or can be finished at a customised height with a top profile to create a railing. Perfect as a border for terraces or balconies in the hotels, restaurant and catering sector.

The support structure ensures an invisible connection between the finishing blades, which creates an unbroken line along the entire passage width.

The wall fits neatly into the space in the columns on both the front and back sides. Differences of height in the floor of up to 6 cm are corrected by the finishing skirting-board, so that there are no disruptive gaps visible at the bottom.

The Linius wall is custom finished in the colour of the covering or of your choosing. Moreover, the double-sided wall allows for the application of sound proofing. This way you can enjoy the nature around your covering in utter relaxation.





Linus fixed wall, bar height, double-sided



Linus fixed wall, full height, single or double-sided

LOGGIA® EASY PASSAGE / SLIDING DOOR (NOT WITH TOSCANE®)

Perfect for when the terrace covering is completely enclosed (using Fixscreen, for instance) and you want to have easy passage from in or out of the terrace covering without having to open the Fixscreen (the comfort of those sitting under the terrace covering is maintained).

Types

- Loggiawood: wooden blades (Western Red Cedar)

- Loggialu: aluminium blades
- Loggiascreen Canvas: fabric screen (fibreglass)

Integration

Camargue and **Skye**: available in Span and/or Pivot

Lagune: available in Side and/or Front

Lapure: available in Side and/or Front
Width: min. 800 mm – max. 1,200 mm



Camargue fitted with an integrated Fixscreen and sliding door using Loggiascreen Canvas in the Span side



Lagune fitted with an integrated Fixscreen and sliding door using Loggiascreen Canvas in the Side



Lagune fitted with an integrated Fixscreen and sliding door using Loggiascreen Canvas in the Front

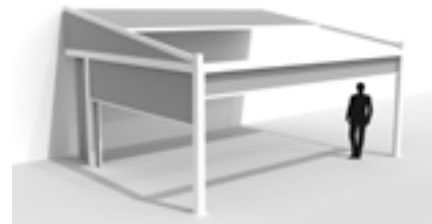

Lapure fitted with an integrated Fixscreen and sliding door using Loggiascreen Canvas in the Side



INTEGRATED FIXSCREEN® (CAMARGUE®, SKYE®, LAGUNE® AND TOSCANE® FRONT)

Perfect integration, even afterwards!

Perfect for:

- Privacy
- Shade when the sun is low in the sky
- Protection from wind, rain and insects

Thanks to an ingenious zipper system, the fabric is windproof in every position and is insect-proof when closed. It is an incredibly well-thought-out principle in which the sun protection fabric has a special zippered trim. This ensures that the entire structure is held firmly by the two side guides.

By integrating this Fixscreen, with or without Crystal windows to keep a view of the outside, you can create an extra outdoor room where the users are protected from sun, rain and

wind. These screens come in 50 colours and allow you to customise the **Camargue**, **Skye**, **Lagune** and **Toscane** and create the atmosphere you desire.

The frame profiles are developed in such a way that the bottom bar is aesthetically hidden away in the box when the screen is raised.

Connect&Go technology

The integrated Fixscreen is fitted with our patented Connect&Go technology. This new development provides an enormous advantage for installation, as well as for removing the fabric roller tube when replacing a screen or motor.



Bottom bar disappears into the Camargue box



FIXSCREEN BASE® (ALGARVE®, TOSCANE® SIDE, AND LAPURE®)

Enclosing the sides

To close off the sides of the **Algarve**, **Toscane** or **Lapure**, these can be combined with the Fixscreen 100^{EVO} Slim F or the Fixscreen 150^{EVO} F. This allows for the box for the sun protection screen to be mounted underneath the frame profiles so that this connects perfectly with the basic construction.



FIXSCREEN® FIBREGLASS FABRIC SCREENS (CAMARGUE®, ALGARVE®, SKYE®, LAGUNE®, TOSCANE® AND LAPURE®)

Transparent sun protection fabric

The best choice in transparent sun protection fabric for windproof vertical sun protection is fibreglass fabric. Fibreglass fabrics score the highest in terms of tension and rigidity, and are also highly resistant to moisture and heat, all while maintaining the view.

We offer a wide range of colours so that you can find the fabric that suits you perfectly.

The "Architects' Selection" is a range of colours that are very popular in the current design and architecture trends.

Our Renson® Ambassadors will be happy to assist you in making your choice.

The fibreglass fabrics are also available with a Crystal window, providing a crystal-clear view.

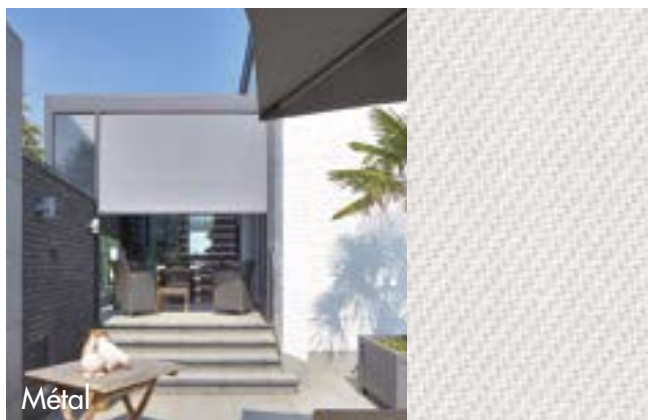

CRYSTAL WINDOWS

Optimum contact with the outdoor space

In order to maintain the highest level of contact with the space outside the covering, transparent Crystal Windows in integrated Fixscreen fiberglass fabric can be installed. This transparent type of fabric is made from PVC (Fire classification M2). The Crystal fabric is welded into a fiberglass screen using high-frequency welding. This fabric can be used in the integrated Fixscreen, Fixscreen 100^{EV0} Slim F and the Fixscreen 150^{EV0} F.

There are various options where you can choose between three types of windows:

- One window of 1,200 mm by min. 1,200 mm
- 2 windows* next to each other
- 2 windows* one above the other

A total of two Crystal windows can be installed per screen. There must be a minimum distance of 200 mm between the sides of the fabric and between the Crystal windows themselves. There must be a distance of 400 mm between the Crystal windows and the bottom and the top edges of the fabric.

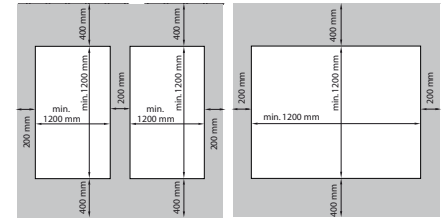

* Either the height or the width must be 1,200 mm. The other dimensions must be at least 1,200 mm.



TRANSLUCENT BLADES - LINEO® LUCE (CAMARGUE®, ALGARVE® AND ALGARVE® ROOF)

Increased elegance thanks to completely transparent blades.

Renson® offers the option to integrate translucent **glass blades**, specifically Lineo Luce, into the **Camargue**, **Algarve** and **Algarve Roof**, when these have adjustable aluminium blades.

When you fit part of your terrace covering with translucent blades, you create a sense of more openness. This is a way to bring more light inside when adding on to your home.

A total of five translucent blades can be installed per roof section with a maximum width of 4 m. These can either be put all together or spread out across the whole of the roof section.

The perfect solution for letting the light in even when the roof is closed!





Light in the home with the roof closed.

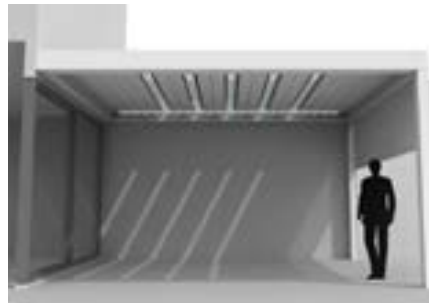

Light under the terrace covering with the roof closed.

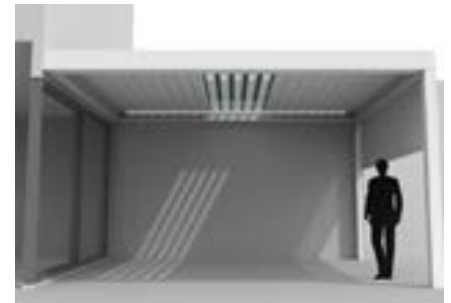

RENSONSCREEN® WATERPROOF ROOF SCREEN (LAPURE®, LAGUNE® AND TOSCANE®)

The **Lapure**, **Lagune** and **Toscane** roofs are fitted with an innovative, waterproof, transparent sun protection screen. One side of this polyester screen is coated with UV-resistant, waterproof coating. This screen is available in various colours.



SWC M005

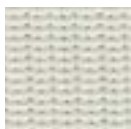

SWC M006



SWC M652



SWC M654

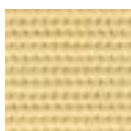

SWC M711



SWC M712

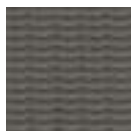

SWC M715



SWC M721



SWC M939

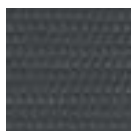

SWC X392*



SWC X393*

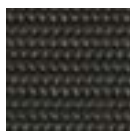

SWC X391*



COLOUR SELECTION ALUMINIUM

Available in all standard RAL colours

Our terrace coverings are powder-coated with **"Seaside quality"** pretreatment as standard. The products are available in all RAL colours in architectural textured finishes at no extra cost.

RENSON® recommends using architectural textured coatings to get an architectural, contemporary look. Moreover, architectural textured coatings are better suited for use outdoors and scratches are less visible.



AUTOMATION

Easy remote operation

You can operate your terrace covering easily using Somfy automation. You can operate the roof and/or the screens of your terrace covering by remote control. Depending on the desired use and the number of screens, you can choose from several different remote controls.

Thanks to TaHoma, the new Somfy user interface, your terrace covering can be operated from your smartphone, tablet or computer.

We recommend installing rain and/or wind sensors for an optimum level of comfort.



somfy.

TESTS

Protection and comfort

Our terrace coverings offer protection and comfort at various levels. In order to guarantee this comfort, they are thoroughly tested for water resistance, load-bearing capacity and wind resistance.

Water tests

The water resistance and water drainage are tested using a spray installation that mimics rain. For example, we check the how much flow our terrace coverings can drain and how this drainage can be optimised:

Camargue: Camargue can drain an amount of water equivalent to rains with an intensity of 180 mm/hr that last up to 2 minutes. These kinds of rains occur on average once every 15 years in Belgium. [See Belgian rain statistics: NBN B 52-011 norm]

Algarve: Algarve can drain an amount of water equivalent to rains with an intensity of between 144 mm/hr and 180 mm/hr that last up to 2 minutes. These kinds of rains occur on average once every 10 years in Belgium. [See Belgian rain statistics: NBN B 52-011 norm]

Lagune: Lagune can drain an amount of water equivalent to rains with an intensity of 180 mm/hr that last up to 2 minutes. These kinds of rains occur on average once every 15 years in Belgium. [See Belgian rain statistics: NBN B 52-011 norm]



Load-bearing capacity

Terrace coverings are subjected to external various forces (e.g. snow). The load-bearing capacity is determined using static strength calculations carried out by our engineers and validated through internal tests.

Camargue: even the largest dimensions of the terrace covering will remain upright with a load of 200 kg per m².

- This is equal to 2 metres of fresh snow per m².
- This is possible thanks to the patented frame span system.



Wind tests

In order to determine the wind forces that our terrace coverings and vertical sun protection screens can withstand, wind tunnel tests were carried out.

	Warranty with closed roof/screen up to	Operating roof/screen to
Camargue	160 km/hr 12 Beaufort	50 km/hr 7 Beaufort
Skye Algarve	120 km/hr 11 Beaufort	50 km/hr 7 Beaufort
Lagune	120 km/hr 11 Beaufort	50 km/hr 7 Beaufort
Lapure	100 km/hr 10 Beaufort	50 km/hr 7 Beaufort
Integrated Fixscreen	60 km/hr 7 Beaufort	30 km/hr 5 Beaufort
Toscane	49 km/hr 7 Beaufort	30 km/hr 5 Beaufort



Beaufort scale

Beaufort	Description	Average speed in m/s	Average speed in km/h	Results
0	Calm	< 0.2	< 1	You don't feel the wind. Smoke will rise virtually straight up.
1	Light air	0.3 - 1.4	1 - 5	Wind direction can be read from the smoke plume, but not from the weather vane.
2	Light breeze	1.5 - 3.4	6 - 12	Wind can be felt on the face, leaves rustle, the weather vane moves visibly with the wind.
3	Gentle breeze	3.5 - 5.4	13 - 19	Flags wave and leaves move about constantly
4	Moderate breeze	5.5 - 7.4	20 - 27	Dust blown up irritates eyes. Hair is awry.
5	Fresh breeze	7.5 - 10.4	28 - 37	Bushes rustle, white tops on lakes and canals.
6	Strong breeze	10.5 - 13.4	38 - 48	Umbrellas are difficult to hold on to, large branches sway, power lines hum
7 FIXSCREEN® TOSCANE®	High wind, moderate gale, near gale	13.5 - 17.4	49 - 62	It is difficult to walk into the wind. Trees sway.
8	Gale, fresh gale	17.5 - 20.4	63 - 73	Making headway is very difficult. Small branches break off.
9	Strong/severe gale	20.5 - 24.4	74 - 87	Chimney tops, roofing tiles and antennas blow away.
10 LAPURE®	Storm, whole gale	24.5 - 28.4	88 - 102	Adults blow over. Major damage to buildings.
11 ALGARVE®, SKYE®, AND LAGUNE®	Violent storm	28.5 - 32.4	103 - 117	Major damage to houses and forests.
12 CAMARGUE®	Hurricane force	> 32.5	> 118	Total destruction

WARRANTY*

High quality

All of the materials we use are of high quality and have been modified for the intended purposes. As manufacturer, we guarantee:

- 5-year* warranty on all defects arising from normal use and maintenance.
- 2-year warranty on the electronic operating system.
- 2-year warranty on the Crystal window fabric.
- 10-year colourfastness warranty for the powder-coating of the aluminium components.
- 5-year warranty on the gloss of the lacquered profiles.
- 7-year warranty on the Fixscreen® technology: zipper must remain in side guide + optimal connection between zipper and fabric.



* See our warranty terms and conditions.

MAINTENANCE

Easy maintenance using the Renson Maintenance Kit

Your terrace covering will always be exposed to the elements outside. If you want to be able to enjoy your Renson covering to the fullest at any time, then we recommend having it maintained regularly, i.e. once or twice a year. This means the covering will last longer. The following are important:

- The structure is made using powder-coated aluminium. An annual cleaning using the **Renson Maintenance Kit** products will ensure that the intense colour is maintained for years, as well as providing extra protection from acid rain, sea air and UV rays. We recommend carrying out maintenance on your installations at least twice a year in coastal or forested regions.
- The **Renson 'Clean'** is a concentrated product with strong cleaning and degreasing properties to deal with the most frequent kinds of natural filth, such as dust, oily precipitation, grease stains, moss, insect remains, etc. This product cannot be compared to the most common cleaning products. Because it works into the installation, the dirt is "lifted out". This product can also be used to clean the polyester fabric roofs and vertical glassfibre fabric screens. After cleaning, you must protect the aluminium structure using **Renson 'Protect'**. This leaves a protective film that

allows the surface to be cleaned by simply wiping it down using a minimum amount of **Renson "Clean"**. It also protects the aluminium from acid rain, sea air, UV rays, and ensures that the colour remains just as intense.

- Do not use either product in direct sunlight or in hot weather. The product's quick-drying action can leave stains on the structure or the fabric screen. Do not use corrosive or harsh products, scourers or other scouring products. Do not use high-pressure equipment in any case whatsoever.



Renson Maintenance Kit

FAQ AND TIPS

Column positions - Camargue, Algarve and Lapure

Camargue, Algarve and **Lapure** can be ordered with "shifted" columns too. This can be useful if, e.g. the terrace covering needs to come out further than the terrace (but the columns still need to be on the terrace) in order to provide enough shade even when the sun is low in the sky.

You can also opt for shifted columns due to placement or architectural reasons. The column can be shifted a maximum of 1/5th of the total Pivot length.



Blade rotation direction - Camargue en Algarve

Think about the direction you want your blades to rotate. Do you want to be able to protect against the sun for as long as possible or allow as much light in as possible?

You can make this choice with Renson®. E.g. when adding on to a kitchen or a living room, people usually want to get as much light in as possible.

① The blades rotate as standard, to the extent that the southern sunlight is blocked when opening the blades. You can also slightly turn the standard sun protection blades in by rotating them more.

② When the blades are slightly turned in, the blades will move into the correct angle more quickly and the smooth, lovely underside remains visible.

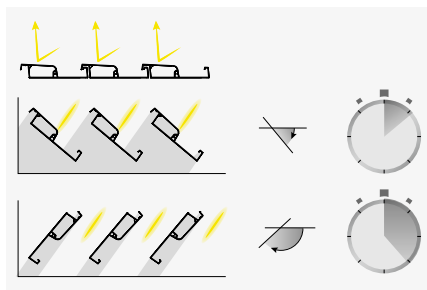

- ① STANDARD SUN PROTECTION:
Slightly held back when opening [perfect for high usage in the summer]

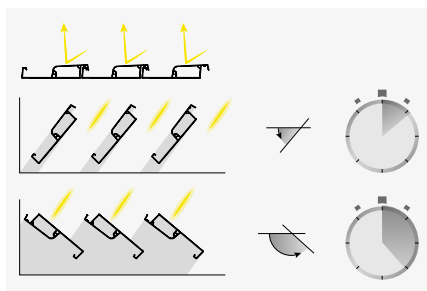

- ② Slightly held back when opening [perfect for high usage in the winter]

Blade colours - Camargue, Skye and Algarve

Camargue, Skye and **Algarve** are available in two-toned colours [frame and columns in a different colour than the roof blades] at no extra cost. Tip: select a lighter colour for the blades when the structure is a darker colour. A darker roof blade colour creates the impression of a lower ceiling. A lighter colour creates a sense of more space.



Veranda

Is a terrace covering like **Camargue** or **Algarve** similar to a veranda? No! A veranda is an extension of the living space enclosed in glass and creates an enclosed space that is completely wind and waterproof. In contrast, a terrace covering is an open aluminium structure with a roof of rotating, aluminium blades that (possibly combined with side panels) primarily offers shelter from the sun and, to a certain extent, bad weather. It is the outdoors that permeates the space under a terrace covering so that the users can enjoy the ambiance, scents, colours and sounds of the garden. So it is best to use weather-resistant garden furniture under the **Camargue** or **Algarve**.

Wind - Camargue and Algarve

If high winds are forecast, we recommend closing the roof panels (this can be done in wind speeds of up to 50 km/h). The entire structure is more solid and can better withstand the wind when the bladed roof is closed. We also offer a warranty on our **Camargue** and **Algarve** with the roof closed for wind speeds of up to 120 km/h!

Fabric screen or blades? - Camargue, Algarve, Lapure and Lagune

How can I choose between a terrace covering with a bladed roof (**Camargue** and **Algarve**) or with a screen fabric roof (**Lapure** and **Lagune**)? Each type of terrace covering has its own advantages. A covering using a sun protection screen can be opened up completely. This way you can keep out the sunlight or let it in completely depending on the weather. Terrace coverings with bladed roofs allow the user to control the amount of sunlight based on what is desired; when there is too much sunlight, the blades can be closed completely, but the roof can never be opened up completely to let in all of the sunlight.



	Bladed roof	Screen roof
Roof	Horizontal	Always at an angle
Position	Constructed, recessed or free-standing	Only constructed
View of "open" roof	Roof blades rotate to open but don't "disappear"	"Roof" completely disappears
Light in a "closed" roof	Opaque (except Lineo Luce blades)	Translucent
Load-bearing capacity	Can bear snow	Cannot bear snow
Colour of the roof	All possible colours	Limited range of colours available for fabric screen roof

Low sun: Fixscreen - Camargue and Lagune

When the sun is low in the sky, sunlight can come in underneath the terrace covering and into your home. This is perfect for naturally warming your house up in the winter. However, this sunlight can be disruptive at times and cause temporary blindness, colours to fade, or reflections on the TV and computer screens. Thanks to the vertical sun protection fabric [Fixscreen] in the sides of your terrace covering, the incoming sunlight is reduced. At the same time, contact with the outdoors is maintained because the fabric is transparent.



Passage height - Camargue and Algarve

The passage height for a bladed roof is optional. People will usually choose a height for a specific situation [e.g. if there is a gutter or window in the way in a construction situation, etc.] or for personal reasons. A tall person prefers a higher passage height to have a certain amount of "openness". On the other hand, it is best to have the lowest possible passage height for the most shade.

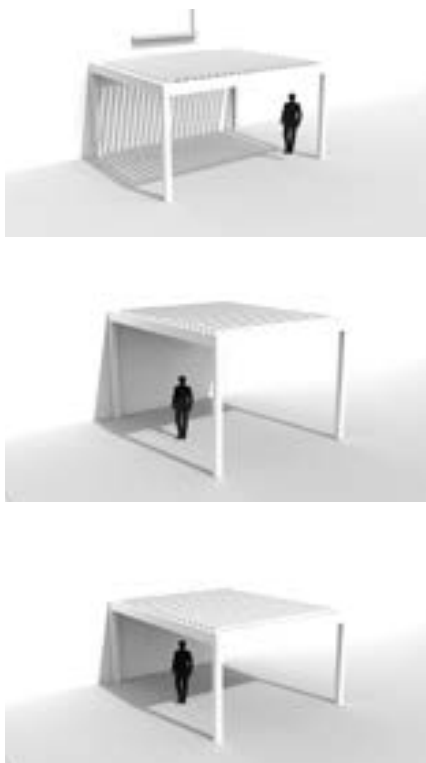

Terrace orientation - Camargue and Algarve

Depending on the orientation of the terrace, you can position the covering differently. A terrace covering with screen fabric or adjustable blades are both good solutions for a terrace facing southwards.

You can keep the heat of the sun at bay by rolling out the fabric or closing the blades. It is best to install the blades of a bladed roof parallel to the home. This way you can best control the amount of sunlight that gets in: entirely or partially kept out or allowed to come in.

It is a good idea to install the blades perpendicular to the wall for a terrace that faces northwards. This is the best way to control the light coming in from the east and west, while the most light can be achieved when open.

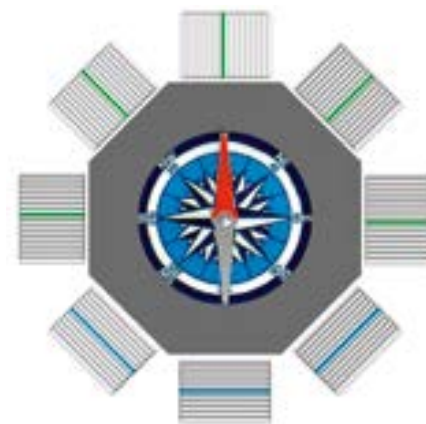

- E-NE-N-NW-W: blades perpendicular to the wall.
- SW-S-SE: blades parallel to the wall.

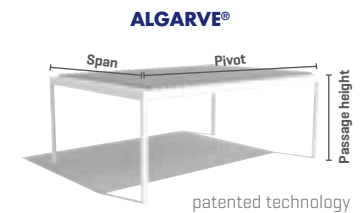
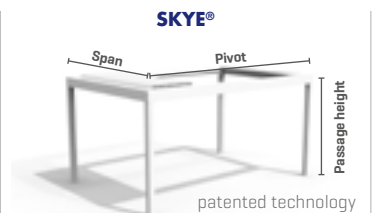
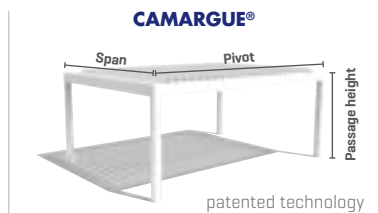

Roof options	Rotating aluminium blades	Rotating, retractable blades	Rotating aluminium blades
DIMENSIONS			
Max. width/Pivot	6,200	6,200	6050
Max. depth/Span	4500	4500	4500
Max. passage height	2,800	2,800	2,800
Joinable	joinable with multiple parts	joinable with multiple parts on the Span side	two-part joinable
Min. angle	no angle [0°]	no angle [0°]	no angle [0°]
TECHNICAL SPECIFICATIONS			
Integrated water drainage	standard (Incl. PVC drainage pipes in column)	standard (Incl. PVC drainage pipes in column)	standard
Integrated cables	standard	standard	not applicable
Integrated motor	standard	standard	not applicable
Operating switch	not applicable	possible	option
RTS operation	standard	possible	standard
io-homecontrol® operation	not applicable	not applicable	not applicable
app operation	not applicable	standard	not applicable
CUSTOMISATION			
Triangle	not applicable	not applicable	not applicable
Glass roof blades - Lineo® Luce	option	not applicable	option
Wooddesign roof blades	option	option	option
Integrated vertical windproof screens	option	option	not applicable
Sliding door Loggiascreen® Canvas	option	option	not applicable
Sliding glass walls	option	option	not applicable
Combination of sliding glass walls + integrated windproof screens	option	option	not applicable
Sliding wall in Loggiawood® / Loggialu® Wooddesign/ Loggiascreen® Canvas / Loggialu® / Loggialu® Stirata / Loggialu® Plano / Loggialu® Linea / Loggialu® Privacy / Loggiawood® Privacy	option	option	not applicable
Windproof screens (surface-mounted) with Fixscreen® 100 EVO Slim F / Fixscreen® 150 EVO F	not applicable	not applicable	option
Integrated LED lighting	option	option	option
Beam with Heat & Sound	option	option	option
Linius fixed wall	option	option	option
Weather-resistant outdoor curtain	option	option	option

* 1 roof section between 4 and 6 m: a connector bar (with or without LED) must be used

ALGARVE® ROOF



patented technology

LAPURE®

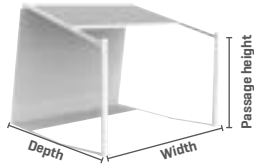

patented technology

LAGUNE®

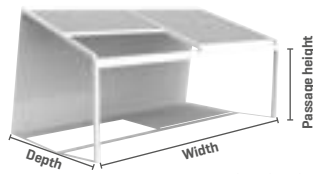

patented technology

TOSCANE®



patented technology

Rotating aluminium blades

Retractable waterproof, transparent sun protection screen

Retractable waterproof, transparent sun protection screen

Aluminium terrace covering with folding roof

6050

6000*

6,000

4500

4500

5000

6,200

6500

not applicable

2900

2,500

2,500

two-part joinable

joinable up to max. width of 18 m

joinable to max. width of 12 m

joinable up to 13 m with a single-fabric screen starting at 4° (depending on the width)

no angle [0°]

10°

8°

standard

standard (depending on the type)

standard
(Incl. PVC drainage pipes in column)

standard

not applicable

standard

standard

not applicable

not applicable

standard

standard

standard

option

not applicable

not applicable

not applicable

standard

standard

option at no extra cost

standard

not applicable

option at no extra cost

standard

not applicable

not applicable

not applicable

not applicable

not applicable

not applicable

option

option

option

option

not applicable

not applicable

not applicable

option

not applicable

not applicable

not applicable

not applicable

not applicable

option

option (Front)

not applicable

option

option

not applicable

not applicable

not applicable

option

option

not applicable

not applicable

option

option (Front)

not applicable

not applicable

option (Side)

option (Front)

option

option

not applicable

option (Side)

option

option

option

option

option

option

option

option

not applicable

not applicable

not applicable

not applicable

not applicable

not applicable

not applicable

not applicable

WHERE CAN YOU AS THE END CLIENT PURCHASE RENSON® PRODUCTS?

To ensure high-quality expertise and professional installation of Renson® products, we have set up a network of well-trained Ambassadors and Installers.

RENSON® PREMIUM Ambassadors

These are ambassadors with years of experience selling and installing Renson® products. They stay updated on the whole range and guarantee the utmost professional assistance.

RENSON® Ambassadors display our products in their showrooms and ensure that the product you have purchased is professionally and properly installed by their own installation team. In addition,

they also guarantee professional after-sales service.

RENSON® Official Dealers display our products in their showrooms and offer you professional advice.

What are the benefits of working with a Renson® Ambassador or Official Dealer?

- He/she is perfectly trained and has the required expertise with regard to our products
- He/she provides you with tailor-made professional advice
- He/she can prepare a correct price quote
- He/she guarantees perfect after-sales

services and is always available to assist you

You will recognise our Renson® Ambassadors, and Official Dealers by the official labels shown here.

See also www.renson-outdoor.com

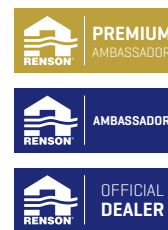

RENSON®: YOUR PARTNER IN VENTILATION, SUN PROTECTION AND THE OUTDOORS

Renson®, headquartered in Waregem (Belgium), is the European trendsetter in natural ventilation and outdoor sun protection.

• Creating healthy spaces

With experience dating back to 1909, we develop energy-efficient total solutions that provide healthy and comfortable indoor environments. Our strikingly designed head office - built according to the 'Healthy Building Concept' - is a beautiful example that reflects our corporate mission.

• No speed limit on innovation

A multidisciplinary team of more than 80 R&D employees continuously optimises our products and develops innovative total concepts.

• Strong in communication

The contact with the client is the prime consideration. Our own exterior sales team, with more than 100 members of staff worldwide and a strong international distribution network, is available to advise you on-site. EXIT5 in Waregem also gives

you the opportunity to personally experience our products and provides continuous training to our installers.

• A reliable partner in business

Thanks to our environmentally friendly and modern production facilities (including automatic powder-coating installation, anodisation unit, plastics injection moulding, mould-making), with a total surface area of 95,000 m², we can always guarantee optimal quality and service to our customers.





EXIT5

Our head office – the elegant building designed by architect Jo Crepain that has been our company’s calling card for years – has been renovated.

The space underneath the building was enclosed with an imposing glass façade. Behind that façade, a new “Customer Centre” was created with reception rooms for clients, meeting rooms and an auditorium where large groups of more than 250 people can attend presentations. This auditorium can also be divided into three separate spaces for smaller groups.

The project’s eye-catcher will be the new 1,250 m² showroom where both professional clients and customers are welcome. In addition to a display room for the various innovative Renson® solutions and concepts, this space will also become a centre of expertise, where customers can find answers to questions about ventilation, sun protection, intensive ventilation, acoustics, etc.

BUILDING OR RENOVATIONS PLANS?
VISIT OUR SHOWROOM

WWW.EXIT5.BE
ALSO OPEN ON SATURDAY!

EXIT5 IS OPEN

Monday to Friday: 8 a.m. - 6 p.m.

Saturday: 9 a.m. - noon

Or make an appointment on 0032 (0)56 62 96 87

Maalbeekstraat 10 • 8790 Waregem • Belgium



BUILDING OR RENOVATIONS PLANS? VISIT OUR SHOWROOM

WWW.EXIT5.BE
MAALBEEKSTRAAT 10 • 8790 WAREGEM



Your dealer



- www.fb.com/rensonworldwide
- [@rensonworldwide](https://www.instagram.com/rensonworldwide)
- [@rensonworldwide](https://twitter.com/rensonworldwide)
- www.pinterest.com/rensonworldwide
- www.youtube.com/user/RensonMarketing



RENSON® Headquarters
Maalbeekstraat 10, IZ 2 Vijverdam
B-8790 Waregem, Belgium
Tel. +32 (0)56 62 71 11
export@renson.net
www.renson-outdoor.com

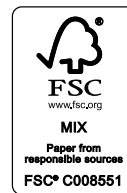

L2000905 09/17 English

